

MASTERTRACE

MS-2101

HEAT TRACING CONTROL

OPERATOR'S MANUAL

1 Product Overview	1.1
Introduction	1.1
Specifications	1.2
Summary of Features	1.3
Use of this Manual	1.3
Conventions	1.3
Shipping Content	1.3
Theory of Operation	1.4
2 Installation	2.1
Unpacking the Controller	2.1
Control Module	2.1
Mounting the Controller	2.3
Wire Sizing	2.3
Conduit and Cabling	2.3
Power Wiring	2.3
Heater Wiring	2.3
Ground Connection	2.3
RTD Sensor Wiring	2.3
Communication Wiring	2.4
Alarm Wiring	2.4
3 Getting Started	3.1
Introduction	3.1
Enabling the Heater	3.1
Entering Setpoints	3.1
Testing Heater & Alarms	3.3
Monitoring System Status	3.4
4 Front Panel Operation	4.1
Overview	4.1
Operating the Keypad	4.1
Status Lights	4.1
Alphanumeric Display	4.1
Keypad	4.1
Display Contrast	4.1
Heater Numbering	4.1
Startup Messages	4.3
Status Messages	4.3
Flash Messages	4.4
5 Measured Values	5.1
Overview	5.1
Operating	5.2
Statistics	5.3
6 Setpoint Values	6.1
Overview	6.1
Setpoints Entering	6.2
Setpoint Access Security	6.2
Operating	6.2
Heater Setup	6.5
System Setup	6.8
Setpoint Tests	6.11

7 Alarms	7.1
Overview	7.1
Trip or Failure Alarms	7.1
Process Alarms	7.2
Warning Alarms	7.3
Reset Alarms	7.3
8 Communications	8.1
Overview	8.1
Physical Layer	8.1
Modbus Protocol	8.2
Modbus Memory Map	8.4
Modbus Map Data Format	8.6
9 Commissioning	9.1
Overview	9.1
Requirements	9.1
RTD Input Test	9.1
Heater Voltage and Current Test	9.2
Ground Fault Current Test	9.3
Alarm Output Test	9.3
Override Input Test	9.4
Placing the Controller in Service	9.4
Completing the Installation	9.6
10 Ethernet Communications	10.1
Ethernet Communication in BACnet/IP and MS-2101 Model Option "BAC/BAC1"	10.1
Serial Communication in BACnet MS/TP network	10.2
Ethernet Communication in Modbus TCP and MS-2101 Model Option "ETH/ETH1"	10.2
An Important Note on Ethernet Gateways	10.3
Warranty	Back Cover

Introduction

The MS-2101 single-point heat tracing controller uses a microprocessor and is intended for stand-alone heat trace applications. It can be for use with mineral-insulated, self-regulating or constant-wattage cable for freeze protection, process control and instrument tracing. The MS-2101 is intended for indoor or outdoor installations in ordinary or hazardous locations.

MS-2101 offers many advantages over other heat tracing control schemes, which generally use some combination of mechanical thermostats, custom-built panels or programmable controls to provide control, monitoring and alarm functions. Budgetary constraints usually limit the degree of system fault monitoring to less than optimal levels. This results in periodic costly process shutdowns due to process or hardware malfunctions. Equipment reliability concerns often force plant procedures to include annual thermostat performance checks to ensure that the device is still operating as intended. This can be a tedious, labour intensive job.

A controller is mounted near the pipe being traced to monitor the heater point. This controller can communicate with a single master unit to give complete system monitoring and control from a convenient location. Up to 32 controllers can be monitored on a RS485 data highway to a centrally located master. By connecting controls to a data highway, the MS-2101 can immediately flag alarms caused by heat tracing malfunctions, altered setpoints and monitor actual values from a central location. Each local control is completely independent and will continue to function if the master fails or if the communication link fails. This ensures maximum reliability and minimizes vulnerability in the event of a hardware failure. Additional points can easily be added at any time as easily as a mechanical thermostat can be installed. Unlike control schemes using programmable controllers, no software development is required. The complete system is operational as soon as it is installed.

Figure 1.1 Typical MS-2101 Installation

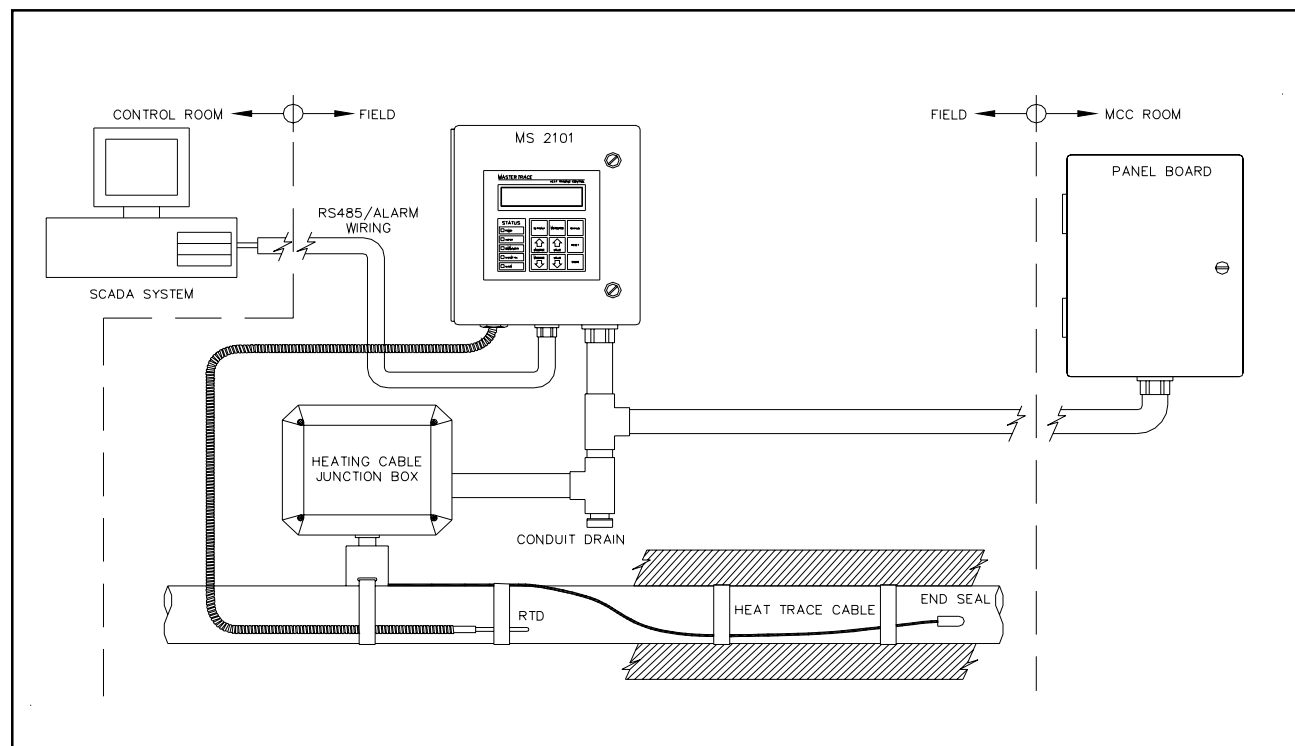

Specifications

Models: MS-2101, MS-2101-E3, MS-2101-BAC, MS-2101-BAC1, MS-2101-E3-BAC, MS-2101-E3-BAC1, MS-2101-ETH, MS-2101-ETH1, MS-2101-E3-ETH, MS-2101-E3-ETH1

Temperature Input

Range: -50 to +500°C (-58 to 932°F)
 Accuracy: ±2°C
 Repeatability: ±1°C
 RTD: Two, 100 ohm platinum, 3-wire RTD, 20 ohms maximum lead resistance

Heater Switching

Configuration: One circuit, Two-pole, one SCR per phase, 800 amp 1 cycle inrush
 Ratings: 85-280Vac, 30A continuous
 Line Frequency: 50 or 60Hz
 Current Measurement: 0.1 to 30A 3%±0.2A
 GF Measurement: 10 to 1000mA 5%±2mA
 Voltage Measurement: 0 to 300Vac 3%±2V

Control Power

Power Requirement: Control power from heater voltage, 85-280VAC, 10VA max
 Protection: Control power from heater voltage protected by 2A fuse, MOV transient protection

Communication

Port: 1 Serial network connection
 Type: RS485
 Protocol: Modbus® RTU.
 Transmission Rate: 600,1200, 2400, 4800, 9600 baud.
 Interconnect: 2-wire, shielded, twisted pair.
 Highway Distance: 4,000 feet without repeater.
 Modules per Highway: 32 Control Modules.

BACnet/IP Ethernet Communication

Models: Models with options BAC/BAC1
 Gateway: 1 configured & assembled MasterTrace Modbus to BACnet/IP gateway, separated from MS-2101 module
 Serial Connection: To be connected to serial ports @ 9600 baud on modules via RS485 cable
 Ethernet connection: To be connected to Ethernet network via Ethernet cable
 Enclosure: FRP enclosure with option BAC1 only

MODBUS TCP Ethernet Communication

Models: Models with options ETH/ETH1
 Gateway: 1 configured & assembled MasterTrace Modbus to Modbus TCP gateway, separated from MS-2101 module
 Serial Connection: To be connected to serial ports @ 1200~9600 baud on modules via RS485 cable
 Ethernet connection: To be connected to Ethernet network via Ethernet cable
 Enclosure: FRP enclosure with option ETH1 only

Measured Values

Temperature: -50 to 500°C (-58 to 932°F)
 Minimum Temperature: -50 to 500°C (-58 to 932°F)
 Maximum Temperature: -50 to 500°C (-58 to 932°F)
 Heater Current: 0.1 to 60A
 Ground Fault Current: 10 to 1000mA
 Min. Heater Voltage: 85 to 300Vac
 Max. Heater Voltage: 85 to 300Vac
 Power Consumption: 0 to 1,000 MWh
 Operating Cost: 0 to \$1,000,000.00

User Interface

Display: 16-character x 2-line LCD Alpha numeric display
 Keypad: 9 tactile keys, polyester faceplate
 - Setpoint, Measured, Status
 - Message Up, Message Down,
 - Value Up, Value Down, Reset, Store

Contrast: Adjustable by potentiometer
 Panel Indicators: Power on, Heater on, Communication active, System fail, Process alarm
 Security: Controller parameters password protected

Environment

Approvals: CSA NRTL/C and FM; Class I, Div. 2, Groups A,B,C,D; Class I, Zone 2, Groups IIC; Class II, Div. 2, Groups F and G; Class III
 Operating Temperature: -40°C to +50°C
 Conformal Coating: Boards conformal coated for hostile environments

Enclosure

Type: Models with option E3: Nema-4X SS steel, painted black
 Models without option E3: Nema-4X steel, painted black
 Size: 0"Hx8"Wx6"D
 Features: Quick release latches to open door, Flat aluminum plate to act as heatsink and mounting flange for mounting on Uni-Strut; One 3/4" conduit knockout for power and three 1/2" conduit knockouts for RTD and signal wiring

Alarm Output

Alarm: Programmable for NO or NC contact
 One Mechanical (dry) contact
 Alarm Rating: Mechanical contact: 30Vdc/100mA, 120Vac/0.52A, 62.5W Max
 Alarm Output: LED Indicator: 5Vdc/50mA

Alarm Function

Temperature: High Temp Alarm, Low Temp Alarm
 Current: Low Current Alarm, High Current Alarm
 Ground Fault Current: Ground Fault Current Alarm, Ground Fault Current Trip
 Voltage: High Voltage Alarm, Low Voltage Alarm
 Hardware: Self-Check Failure, Switch Shorted, RTD Open, RTD Shorted, Continuity

User-Definable Options

Heater Status: Enable or Disable
 Heater Name or Tag: 16 Character Alphanumeric
 Temperature Units: °C or °F
 Proportional Control: on or off
 Deadband: 1 to 50C° (2 to 90F°)
 PowerLimit: 0.1 to 30A, off
 SoftStart: 10 to 999s, off
 TraceCheck: 1 to 24hrs, off
 Temperature Setpoint: -50 to 500°C (-58 to 932°F), off, none
 High Temp Alarm: -50 to 500°C (-58 to 932°F), off
 Low Temp Alarm: -50 to 500°C (-58 to 932°F), off
 High Current Alarm: 0.1 to 30A, off
 Low Current Alarm: 0.1 to 30A, off
 Ground Fault Alarm: 10 to 1000mA, off
 Ground Fault Trip: 10 to 1000mA, off
 High Voltage Alarm: 85V to 300V, off
 Low Voltage Alarm: 85V to 300V, off
 RTD Definition: Single, Backup, Highest, Lowest, Average or High Temperature Cutout
 RTD Fail-safe: Heater On or Heater Off
 Heat Trace Curve: disable, user, LT3, 5, 8, 10, HLT3, 5, 8, 10, 12, 15, 18, 20
 Override: On or Off
 Alarm Contacts: NO or NC for each contact
 Alarm Light: Alarm on, Alarm off, Flash during alarm then on, Flash during alarm then off

Ground Fault

Maximum Trip Time: 3.7 seconds

Summary of Features

Inputs

- 2-RTD Sensors
- 1-Override

Monitoring

- RTD Temperatures
- Heater Current
- Heater Voltage
- GF Current

Alarms

- Low and High Current
(Compensated by heat trace curve for Self-regulating cable)
- Low and High Temperatures
- Continuity
- GF Alarm
- GF Trip
- Switch Failure
- Sensor Failure
- Self-Test Failure

Outputs

- 1-Mechanical (dry) Contact
- 1-LED Alarm Indicator

Statistics

- Minimum and Maximum Temperatures
- Maximum Current
- Maximum Ground Fault
- Minimum and Maximum Voltage
- Energy (MWh)
- Energy Cost

Control

- Temperature (On/Off- Deadband)
- Temperature -Proportional
- PowerLimiting
- Softstart

Early Warning (TraceCheck)

- Low and High Current
- Continuity
- GF Alarm
- GF Trip

Communications

- 1-RS485
- Modbus Protocol

Environment

- CSA Certified and FM Approved for Hazardous Locations
- Weatherproof, NEMA-4X Enclosure
- -40°C to +50°C Operating Temperature Range (LCD: -20°C to +50°C)

User Interface



- 32 Character LCD Display
- LED Indicators on Faceplate
- Clear, English Language Messages
- Intuitive Message Structure
- Tactile Keys
- Access Security

Using This Manual

Detailed information relating to switch and output ratings, accuracy and so forth are detailed in *Chapter 1 Specifications*. *Chapter 2 Installation* discusses important mounting and wiring issues for reliable operation. *Chapter 3 Getting Started* provides a step-by-step tutorial for a heat trace application. The remainder of this manual should be read and kept for reference to provide the maximum benefit of the MS-2101.

Conventions

The following conventions are used in this manual.

-  User Changeable Values
-  Retrieved Data
- [] Key Press

Shipping Content

MS-2101 Heat Trace Controller
MS-2101 Instruction Manual with Warranty Card

Theory of Operation

Controller functions are controlled by a Intel 80C32 8-bit microprocessor that measures all analog signals and logic inputs, control heater output and alarm contacts, and reads all user input including communications and outputs to the faceplate display and LEDs. Consult the hardware block diagram in figure 1.8 for details. The remainder of this chapter describes the algorithms and operation of some of the controller functions.

RTD Sensing

An RTD changes its resistance in a precision relationship to temperature. This resistance is sensed by passing a constant current through the RTD and measuring the resulting voltage across the RTD (resistance = voltage/current). The voltage appearing across RTD1 terminals 6&8 and RTD2 terminals 10&12 also includes the resistance of the inter-connecting wiring to the RTD, which varies with wire length, size and ambient temperature. By using a three-wire sensing scheme and a lead resistance compensation circuit, the lead resistance is cancelled out to give a voltage proportional to the true RTD sensor temperature.

RTDs respond in a known but non-linear fashion to temperature, which if uncorrected could lead to significant errors over the temperature range of the controller. Consequently, some means is needed to convert the input voltage to a linear and useful range. The CPU applies gain, offset and non-linearity corrections through a

linearization algorithm.

Current, Ground Fault and Voltage Sensing

Current transformers and high impedance voltage dividers are used to scale-down the incoming heater current, ground fault current and voltage. All three signals are then passed through a full wave rectifier and filter to obtain a DC signal. The DC signals are then converted to digital values by a 10 bit A/D converter before finally being passed on to the CPU for analysis.

Each of the three DC signals are sampled 300 times with zero cross synchronization so that the sampling covers an exact span of ten power cycles. This is to ensure that heater current values are consistently measured when the heater output cycle is modulated by the powerlimit, softstart or proportional control functions.

Powerlimit

The powerlimit function allows the heater to operate below its rated power by cycle modulation. Cycle modulation is accomplished by controlling the integral number power cycles into the heater over a periodic time frame. The MS-2101 uses a ten cycle time frame. The integral number of power cycles per time frame is called a *duty cycle*. With a ten cycle time frame, there are ten duty cycles possible. For each duty cycle, there is a fixed pattern that defines the number of power cycles in which the heater is on and off. This is shown in figure 1.2:

Figure 1.2 Cycle Modulation - 10 Cycle Frame

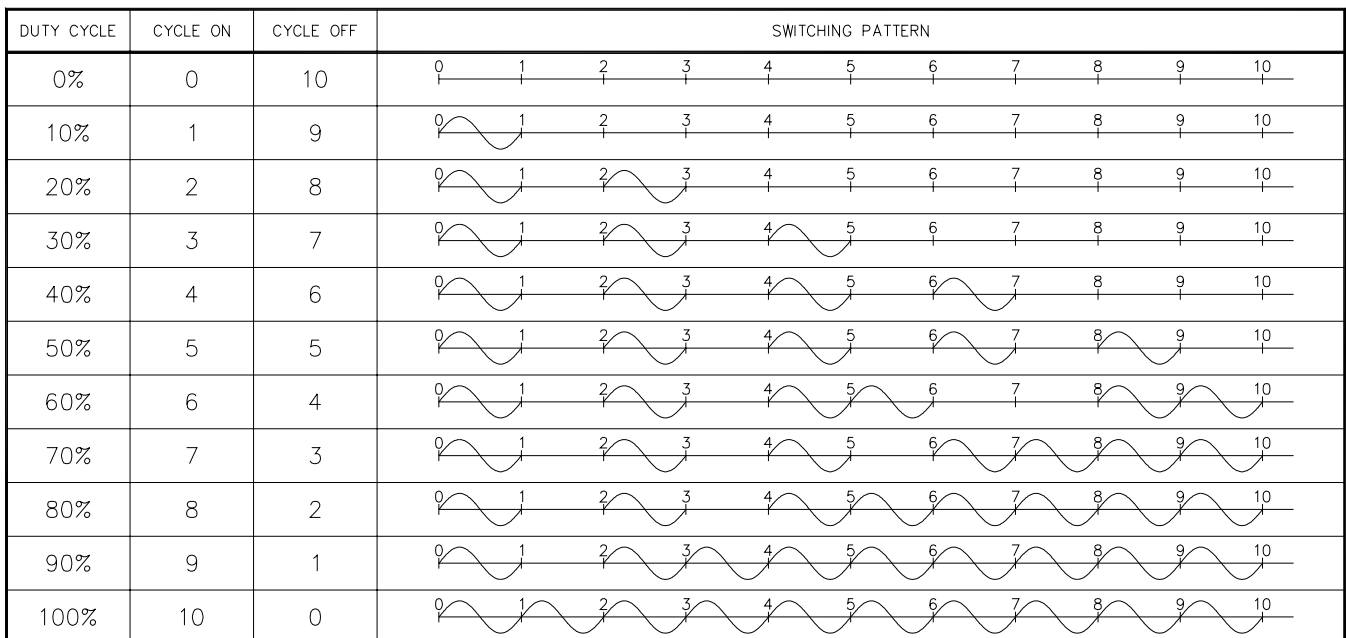

Cycle modulating the current through the heater has the effect of turning the heater on and off rapidly and therefore, power output is reduced in the long run. Since the switching is zero-cross controlled, the controller knows exactly when power cycles start and finish. Zero-cross switching also helps reduce power harmonics that generate unnecessary interference.

The heater current (average current) measured by the controller while cycle modulation is in effect may be approximated as follows:

Heater Current at 100% x Duty Cycle = Average Current

When powerlimit is enabled, a powerlimit current is set by the user. This is essentially the desired average current. The powerlimit control algorithm ensures that the actual current will not exceed the powerlimit setting while optimizing the maximum duty cycle possible. When the average current exceeds the powerlimit setting, the duty cycle is reduced by 10%. When the average current is below the powerlimit setting, the duty cycle is increased by 10%. Before the algorithm increases or decreases the duty cycle, the controller waits until the heater current has reached steady-state at the current duty cycle setting. If the heater is initially off and the controller calls for heat, the duty cycle starts at zero and increases by 10% increments until it reaches a steady-state value. This ramping up effect provides a current-driven softstart whenever the controller calls for heat unlike the softstart function, which is time driven.

Softstart

During cold temperature startups with self-regulating heat trace cables, the current driven softstart built into the powerlimit function may not be long enough to overcome the inrush current. The softstart function is separate from powerlimit and is time driven where for when you set the softstart period. Having the two separate functions is desirable when powerlimit may not be required by the application but softstart is essential to avoid nuisance breaker trips during cold startups. The controller applies the softstart function initial startup when the controller is powered up.

Operation of the softstart function varies depending on whether or not powerlimit and/or proportional control are enabled. When powerlimit and proportional control are off, operation is simplified. The softstart function uses cycle modulation to gradually increase power output over the softstart period. Since most circuit breakers are the thermal type, the cycle modulated output appears as a reduced load to the circuit breaker.

During controller power-up and assuming the controller is calling for heat, the duty cycle starts at 10% and increments by 10% until full power is reached. Since there are ten duty cycle increments, the time that the controller maintains each duty cycle setting is the softstart setting (softstart period) divided by 10. The softstart operation powerlimit and proportional control off is shown by the curve in figure 1.3.

Figure 1.3 Softstart Curve with Powerlimit and Proportional Control Disabled

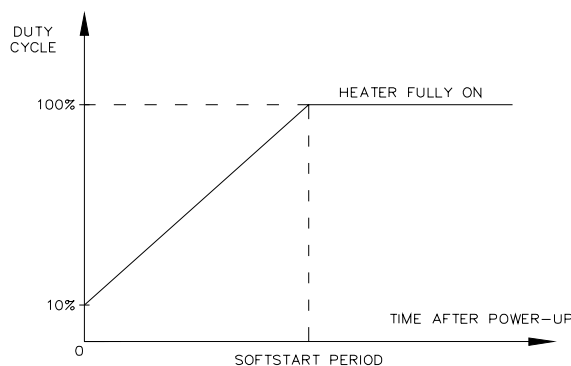

With powerlimit enabled, the only difference is that instead of the duty cycle ramping to 100%, it stops at the value determined by the powerlimit function such that the average current does not exceed the powerlimit current set by the user. The maximum duty cycle setting is approximated by the controller initially so that the time period for each duty cycle increment can be determined. The softstart operation with powerlimit enable is shown by the curve in figure 1.4.

Figure 1.4 Softstart Curve with Powerlimit Enabled

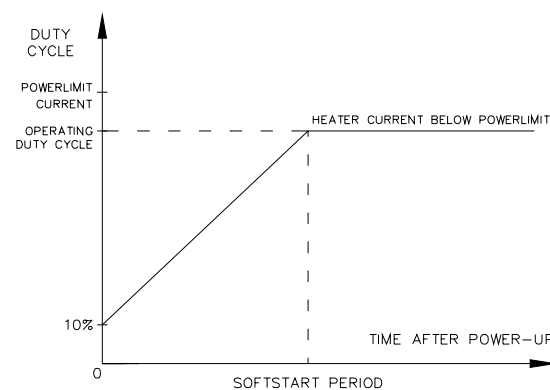

When proportional control is turned on, the maximum duty cycle available to the controller is constrained by the powerlimit current if enabled and softstart.

Proportional Control

Unlike on/off control where the heater is fully on or off, proportional control can partially turn on the heater. The heater output is proportional to the difference between actual temperature and heater setpoint. The relationship is expressed as follows:

(actual temperature – heater setpoint) x k = heater output
 where k is the proportional gain

To partially turn on the heater, the proportional control function uses cycle modulation in the powerlimit function. By incorporating cycle modulation into the proportional control equation, the algorithm is expressed using the following equations:

$$d(t) = 0 \quad \text{if} \quad e(t) \leq 0$$

$$d(t) = \frac{e(t)}{DB(t)} \quad \text{if} \quad 0 < e(t) < DB(t)$$

$$d(t) = 1 \quad \text{if} \quad e(t) \geq DB(t)$$

- Where $d(t)$ = duty cycle
- $DB(t)$ = deadband factor (in °C/duty cycle)
- T_s = heater setpoint temperature (°C)
- $T(t)$ = heater temperature (°C)
- $e(t)$ = $T_s - T(t) = \Delta T$ (°C)
- t = time in seconds

The deadband factor $DB(t)$ is a time constant that determines the slope of change of the proposed heater on duty cycle with the temperature difference. It is adjusted between 1 to 10 each hour to minimize the difference between the measured temperature and the temperature setpoint. Every hour after power up, the controller calculates the absolute values of the temperature differences $e(t)$ and sums them during the hour. Then the total absolute temperature difference is divided by the number of temperature readings taken during the hour. The result is called the Average Absolute Temperature Difference (AATD) for the hour. If current AATD is smaller than the AATD in the previous hour, the deadband factor will be increased or decreased in the same direction. If current AATD is larger than the AATD in the previous hour, the deadband factor will be increased or decreased in the reversed direction. At steady state, the deadband factor used will fluctuate around a optimum value.

Figure 1.5 shows the relationship between the proposed heater on duty cycle and the temperature difference for different deadband factors used.

Figure 1.5 Proportional Control Duty Cycle vs. Temperature Difference

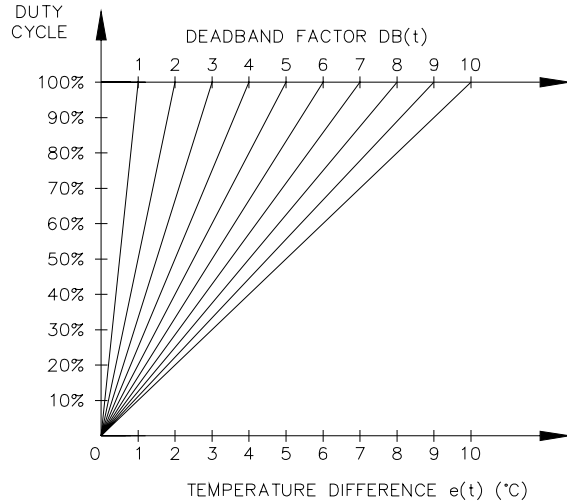

On/Off Control with Deadband

The default control mode of the controller is deadband control or simply on/off control with the proportional control setting turned off. On/off control without deadband (that is deadband set to 0 C° or 0 F°; note that these units denote the temperature differential with “°” placed to the right of the unit) means that the heater turns on when actual temperature is below setpoint and turns off when above setpoint. However, this causes oscillations when the actual temperature is very close to setpoint. To eliminate oscillations, hysteresis is applied to the on/off control by a deadband value. The on/off control with deadband operation is described by the hysteresis curve in figure 1.6. Assume that actual temperature is well below (setpoint - deadband setting), the controller calls for heat. As the actual temperature rises, the controller continues to call for heat until the actual temperature has reached (setpoint + deadband setting). The controller no longer calls for heat and the heater is off. As the actual temperature cools, the controller does not call for heat until the actual temperature reaches (setpoint – deadband setting). The hysteresis effect is controlled by the momentum of the actual temperature rather than the temperature value itself.

Figure 1.6 On/Off Control with Deadband

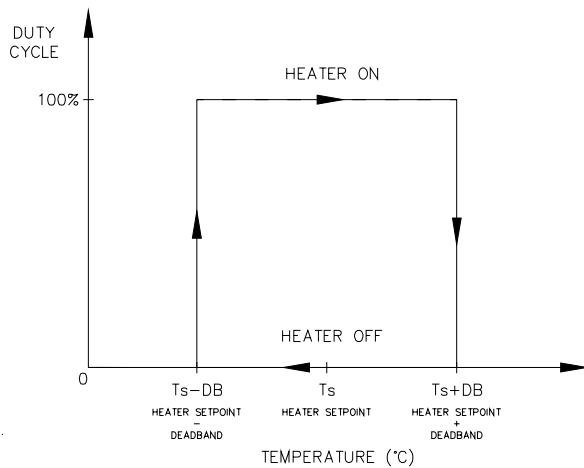
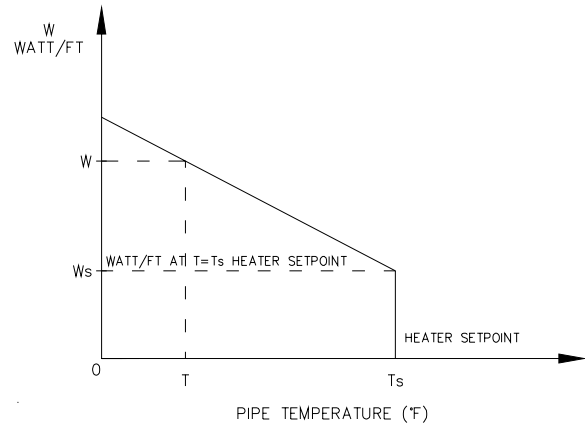

Figure 1.7 Heat Trace Curve



Heat Trace Curve

Monitoring low and high current alarms on self-regulating heat tracing cable is difficult. Choosing a high current alarm setting based on cable characteristics near the heater setpoint temperature will produce nuisance alarms during startup. Choosing a low current alarm setting other than below the current draw of the cable at heater setpoint temperature produces nuisance alarms. The heat trace curve function allows you to program the cable characteristics so that the controller can offset the current alarm settings.

The heat trace curve is described by the following linear equation:

$$W = aT + b$$

where, W is the Watt/ft at temperature T (in degree F), a and b are the slope and offset of the linear curve.

If the Watt per foot value of the heat trace is W_s at setpoint temperature T_s , and the Watt per foot value of the heat trace is W at temperature T, the offset ratio to be applied to the high/low current alarm level is W_s/W .

That is, if the high/low current alarm level is set to I_s , the current draw of the cable at setpoint temperature of T_s , then the high/low current alarm level at operating temperature T should be corrected to $(W_s/W) * I_s$ to compensate the effect of operating temperature on the allowed maximum/minimum heater current. The heat trace curve is shown in figure 1.7.

If no heat trace curve is used, the offset ratio is set to 1 and no correction to the high/low current alarm level is done.

Figure 1.8 Hardware Block Diagram

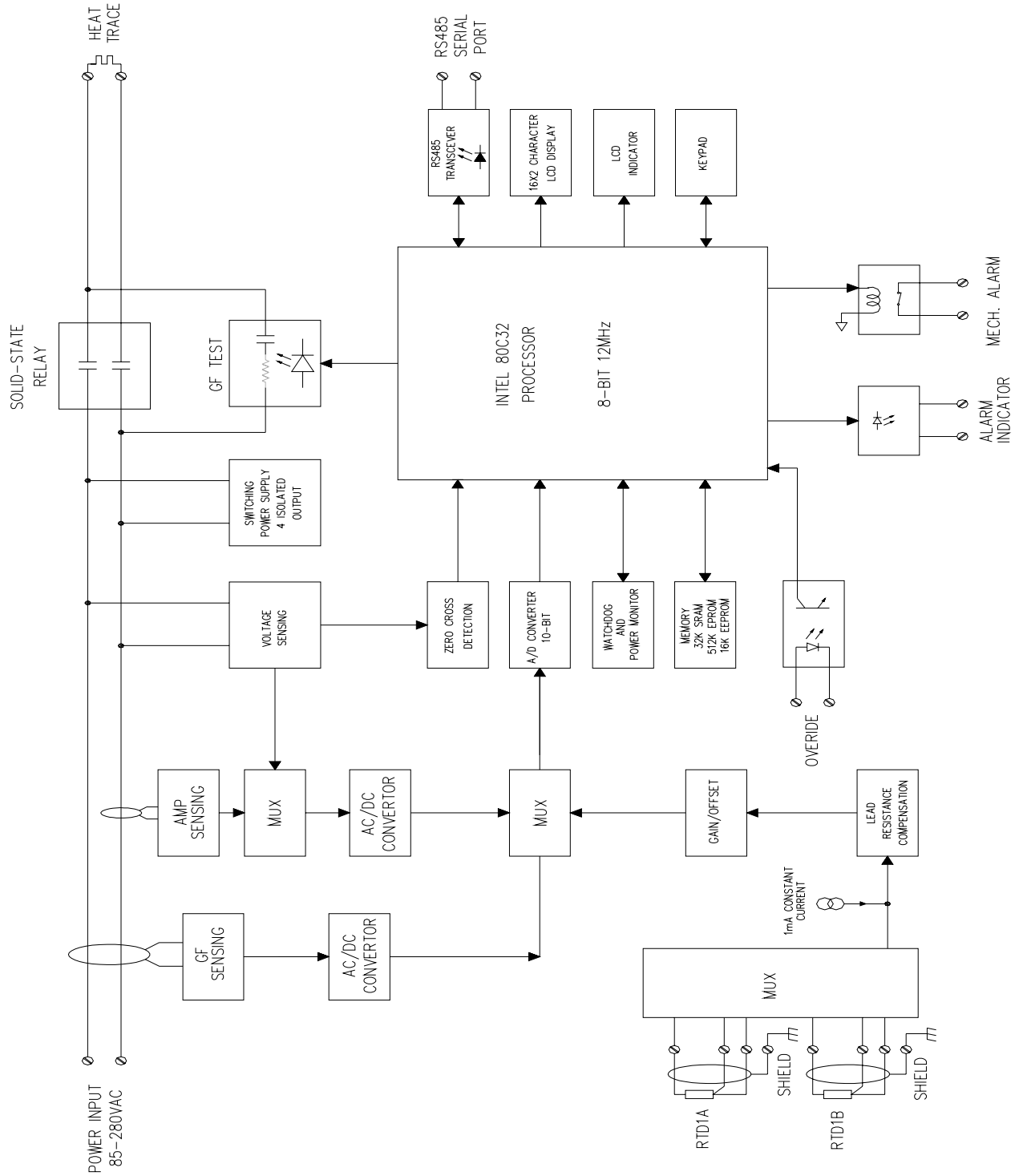

Unpacking the Controller

Check the shipping cartons for damage, or other signs of rough handling or abuse. If damaged, notify the shipping carrier at once.

Carefully remove the MS-2101 from the shipping box. Save the packing materials in case the unit needs to be transported at a later date.

Inspect face plate for damage and check electronics for loose wiring or damage. Report any damage to the carrier at once.

Control Module

See *Figure 2.1 Main Board Layout* and *Figure 2.2 Power Board Layout* to locate the following:

- **S1** Address Enable: When the switch is set to **DIS**, the Module Number cannot be changed from a master on the data highway. When set to **EN**, the Module Number can be changed for the next two minutes from a master on the data highway. During this time the ADDRESS ENABLE light is **on**.
- **S2** Program Enable: When the switch is set to **DIS** and the PROGRAM ACCESS is **disable**, programming is disabled; setpoints and configuration cannot be changed. When set to **EN**, programming is allowed.
- **S3** RS485-120: When the jumper is set to **IN**, the RS-485 line is terminated by a 120 ohm resistor. Only the last Control Module on the data highway should be set to **IN**.

Terminals: Refer to *Figure 2.7 Typical Wiring Diagram*, for power, heater and RTD field connections.

- **T 1** Alarm Contact: The mechanical output is rated 30 Vdc/100mA, 120Vac/0.52A, 62.5W Max. Without power, the contact is open. With power, it is configurable for normally open or closed.
- **T 2** Alarm Light Output: The output is configurable for normally open, closed or flash. Output is rated 5 Vdc @ 50 mA for an LED type lamp (terminals 18+ and 19-).
- **T3** Override Input: With the Override function (SETPOINTS\HEATER SETUP\OVERRIDE) set to **on**, the heater output is affected by the override input. When the terminals are open, the heater is forced off. When the terminals are closed, the heater is controlled by the RTDs unless the heater setpoint is set to off. In this case, the heater is solely controlled by the override input. The logic of this input allows either ambient temperature override or load shedding on multiple controllers (terminals 24+ and 25-).

- **T4** RTD1A and RTD1B Inputs: 3 wire RTD input. Ground terminal connects to shield or case. Lead resistance compensated. (terminals 6-13).
- **T5** Earth Ground: (terminal 1).
- **T6** Heater Power Input: 85-280Vac/30A max continuous (terminals 2 and 3).
- **T7** Heater Power Output: 85-280Vac/30A max continuous (terminals 4 and 5).
- **T8** Safety Ground: Terminate to ground stud. Termination of safety ground is required for transient protection circuit on RTD inputs and RS485 serial port to operate properly (terminal 14).
- **T9** Extra A/D Input/Output: Terminals 22 (POUT) and 23 (PIN) are the output (+12Vdc) and input (4-20mA) connections to a 4-20mA analog signal transmitter.

Status Lights:

- **L1** Power: Light is on when control power is present.
- **L2** Address Enable: Light is on when controller is in **Address Enable** mode. Light must be on to allow the Module Number to be changed from a master on the data highway.
- **L3** Transmit: Flashes when data is being transmitted from the serial port to the data highway.
- **L4** Receive: Flashes when data is being received at the serial port from the data highway.
- **L5** Override: Light is on when the Override Input terminals are shorted.

Communication Ports:

- **C1** Interface to Main/Power Board: Connector to interconnect power and main board via ribbon cable.
- **C2** Serial Port 1: Connection to an RS-485 data highway via a 2-conductor, shielded, twisted pair cable. Maximum Cable length with 32 devices without repeater is 4,000 feet. (terminals 15+, 16-,17 SHD).



Warning - The ground fault trip function is intended for equipment protection only and should not be used in place of ground fault protection for personnel protection where this is required.

Figure 2.1 Main Board Layout

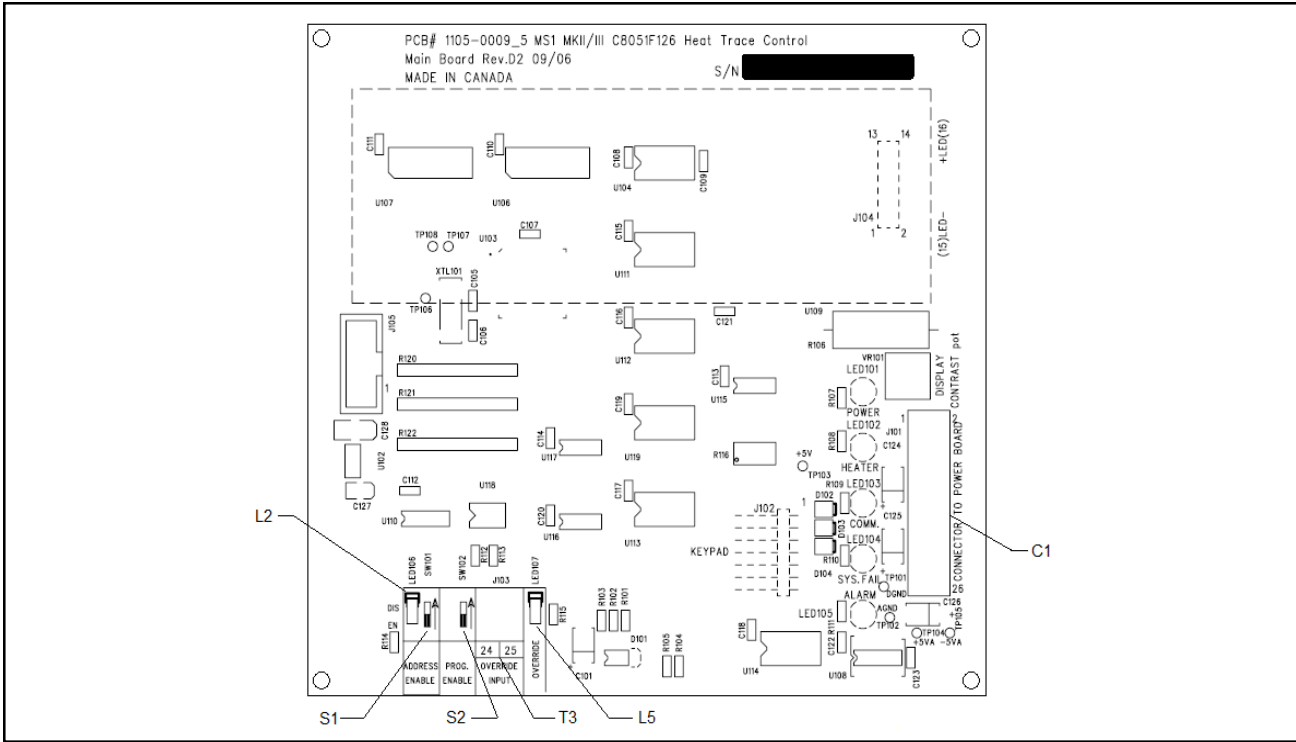
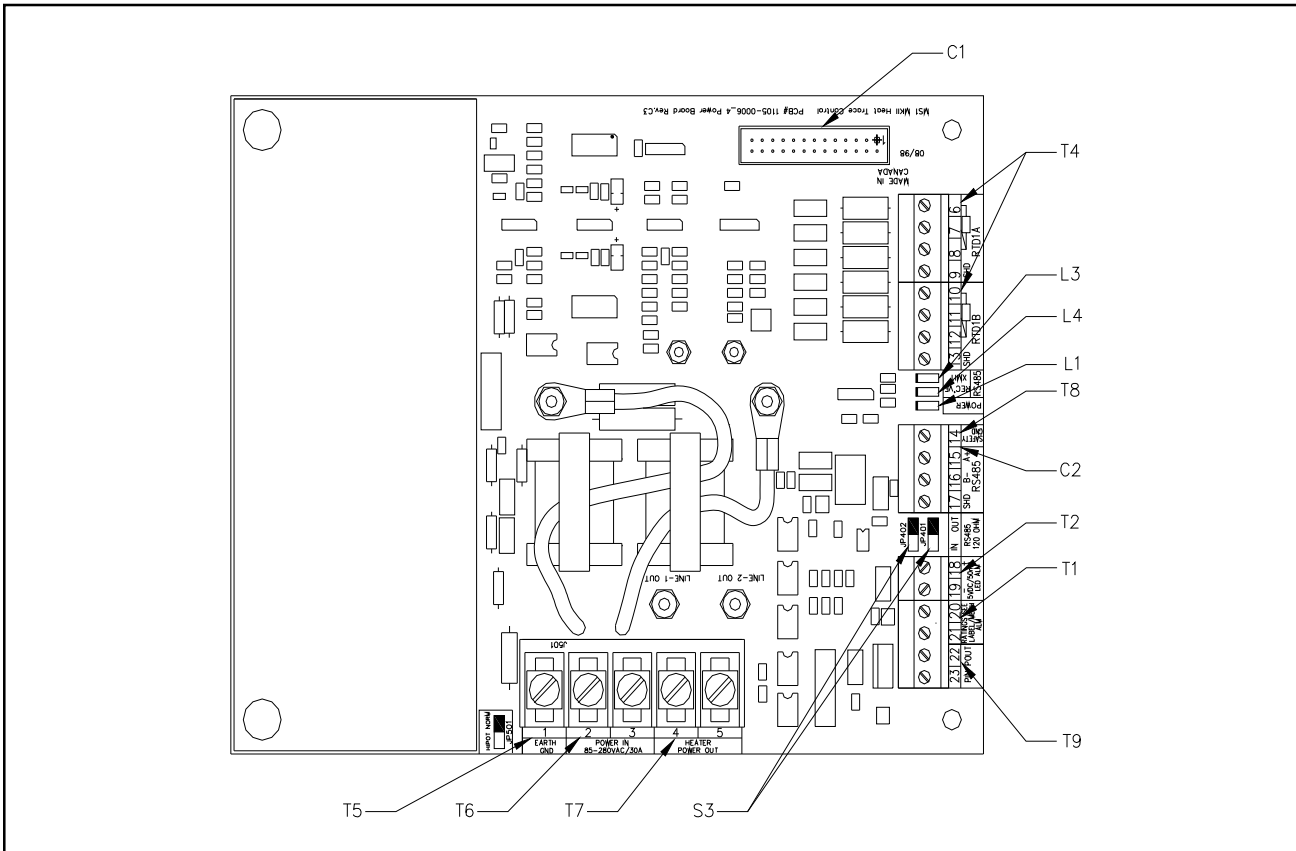

Figure 2.2 Power Board Layout



Mounting the Controller

Mount the control panel with Unistrut brackets using 1/2" bolts. The Unistrut (or equivalent) mounting allows air circulation to cool the heat-sink. This is important to ensure proper operation of the MS-2101. For optimum readability, mount with the display at eye level and not in direct sunlight. Mounting dimensions are shown in Figure 2.6.

Wire Sizing



Wiring methods should comply with Canadian Electrical or National Electrical Code and local codes. Power and signal wires should not be run in the same conduit system. Wiring should be rated at least 90 °C.

Wire Size (AWG)	Current Load (A)	Max. Ambient Temperature (°C)
6	30	50
8	30	40
10	24	50
12	16	50

Conduit and Cabling

The MS-2101 comes with one 3/4" and two 1/2" conduit knockouts located on the bottom of the enclosure. Conduit hubs should be NEMA-4X rated, such as T&B H050-0.5 and H075-0.75 or Myers equivalent, to maintain a watertight seal. Unused knockouts should be sealed using NEMA-4X rated seals.

Power Wiring

The power input terminals supply power to both the heat trace and controller. Size power input wires appropriately to the breaker size and maximum ambient operating temperatures. Maximum breaker size is 30A. Connect power wires to input terminals 2 and 3. See Figure 2.7.



The supply voltage must be within the power supply range of 85-280Vac and rated voltage range of the heat trace cable.

Heater Wiring

Connect heating cable wiring to terminals 4 and 5. See Figure 2.7. If the heating cable has a braid, it should be terminated to the ground stud using a ring terminal suitable for #10 stud.



Wiring methods must conform to Class I, Division 2 or Class I, Zone 2 requirements.

Ground Connection

Connect the controller grounding stud directly to a ground bus using the shortest, practical path. Use a tinned copper, braided bonding cable such as Belden 8660. As a guideline, the ground cables should be minimum 96 strands, number 34 AWG each.

The grounding is not only a safety requirement but is necessary for the input transient protectors or the RTD and communication inputs to work properly. The transient protection network is grounded through terminal 14, safety ground, which is bonded to the chassis ground stud. To install the ground connection, remove the outside nut, washer and #10 ring lug provided on the ground stud. Crimp the ground cable onto the ring lug and re-assemble onto the ground stud using the washer and nut.

Figure 2.3 Ground Connection

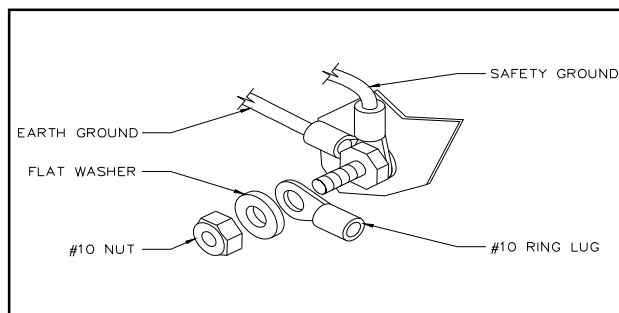

RTD Sensor Wiring

RTD sensors should be 3-wire, 100 ohm, platinum to DIN EN 60751 standard. Mount the RTD element on the pipe, away from the heat trace and 30° to 45° from the bottom of the pipe. The total circuit resistance per conductor from the RTD to the control panel must be less than 10 ohm. Exceeding this resistance will result in a non-linear temperature measurement. Belden cable 8770 or equivalent allows RTDs to be placed up to 1,000 feet from the control panel. Complete all RTD wiring according to Figure 2.7 Typical Wiring Diagram.



The RTD probe is delicate and should not be bent or used as a tool to puncture insulation.

Figure 2.4 RTD Mounting

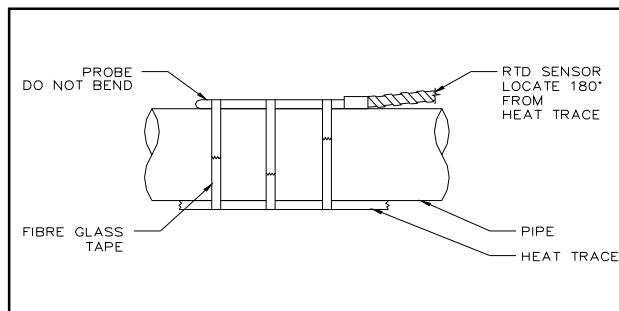

You must install the RTD sensor on the pipe surface or thermal well before the pipe insulation to ensure proper thermal contact. The RTD position should be 180° from the electric heat trace cable which is the coldest spot of the pipe. The RTD sensor may be secured to the pipe by fiber-glass tape. If additional wiring is required for the RTD, shielded 3-lead wire sized 18 or 20AWG must be used for the RTD sensor to minimize the effects of noise pickup. A typical RTD installation is shown in *Figure 2.4*.

Communication Wiring

The MS-2101 is equipped with a communication port that provides continuous monitoring and control from a remote computer, SCADA system or PLC. Communications protocol is Modicon Modbus as discussed in the communications chapter. Communication is RS-485 mode where data transmission and reception are done over a single twisted pair with transmit and receive data alternating over the same pair of wires. Shielded twisted pair such as Belden cable 9841 or equivalent is recommended to minimize error from noise. You must observe polarity. For each MS-2101 controller, you must connect A+ terminals together and B- terminals together. The shield terminal (labelled SHD) connect to shield wire of the cable. To avoid loop currents, the shield should be grounded at one point only. Connect between controllers in daisy-chain fashion. The total length of this daisy-chain should not exceed 4,000 feet. The maximum number of devices connected is 32 to avoid exceeding driver capability. You

can use commercially available repeaters to increase the number of devices over 32. Avoid star or stub connections.

Terminate the last device in the daisy-chain loop. Each controller is equipped with a termination jumper as shown in *Figure 2.2*.

The controller comes unterminated from the factory (JP401 and JP402 in **OUT** position). If the controller is the last device, it can be terminated by moving the two jumpers (JP401 and JP402) to the **IN** position.

The communication port is powered by an isolated power supply with opto-coupled data interface to eliminate noise coupling. In addition, surge protection devices are employed at the front end of the port to protect against lightning strikes and ground surge currents. These may cause large, momentary voltage differences between devices on the data highway.

Alarm Wiring

The MS-2101 has one passive (mechanical) alarm contact and one active alarm output for driving an LED alarm indicator. Without power, the alarm contact is open. With power, it is software configurable for normally open or closed. The alarm LED output is software configurable for alarm on, alarm off or flash during alarm. Refer to *Figure 2.7* for alarm output terminals.

The mechanical (dry) alarm output is rated 30Vdc/10mA, 250Vac/0.5A Max.

The alarm LED output is rated 5Vdc, 50mA. It can drive a 6Vdc LED indicator. Alarm output is designed for interface to annunciator, panels, PLC or DCS.

Figure 2.5 Communication Wiring

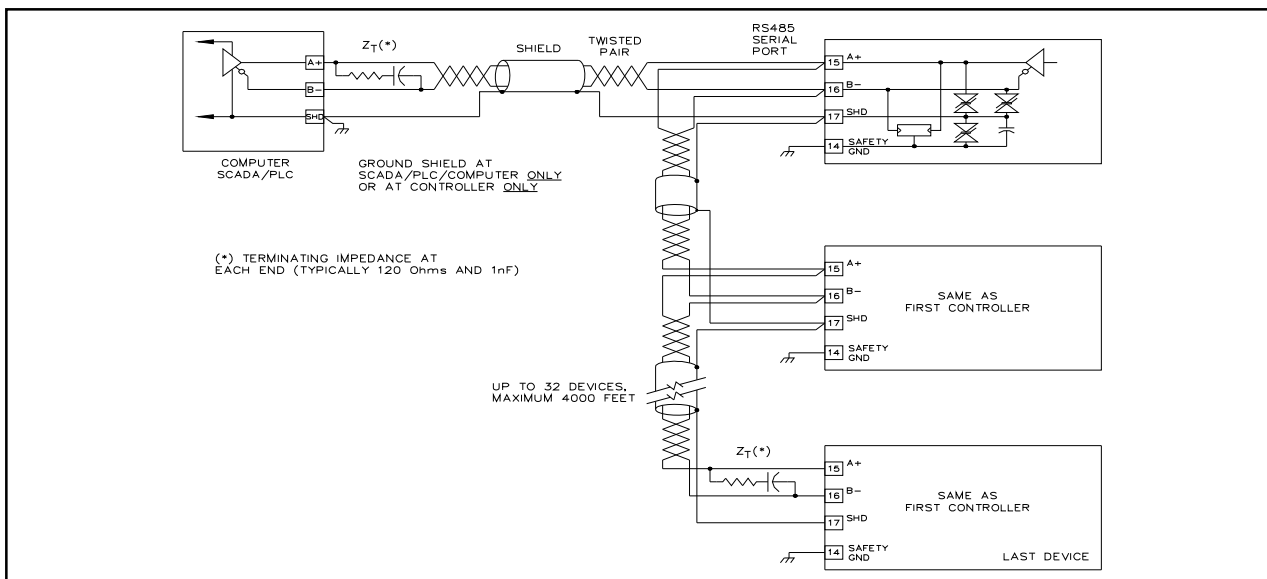

Figure 2.6 Mounting Dimensions

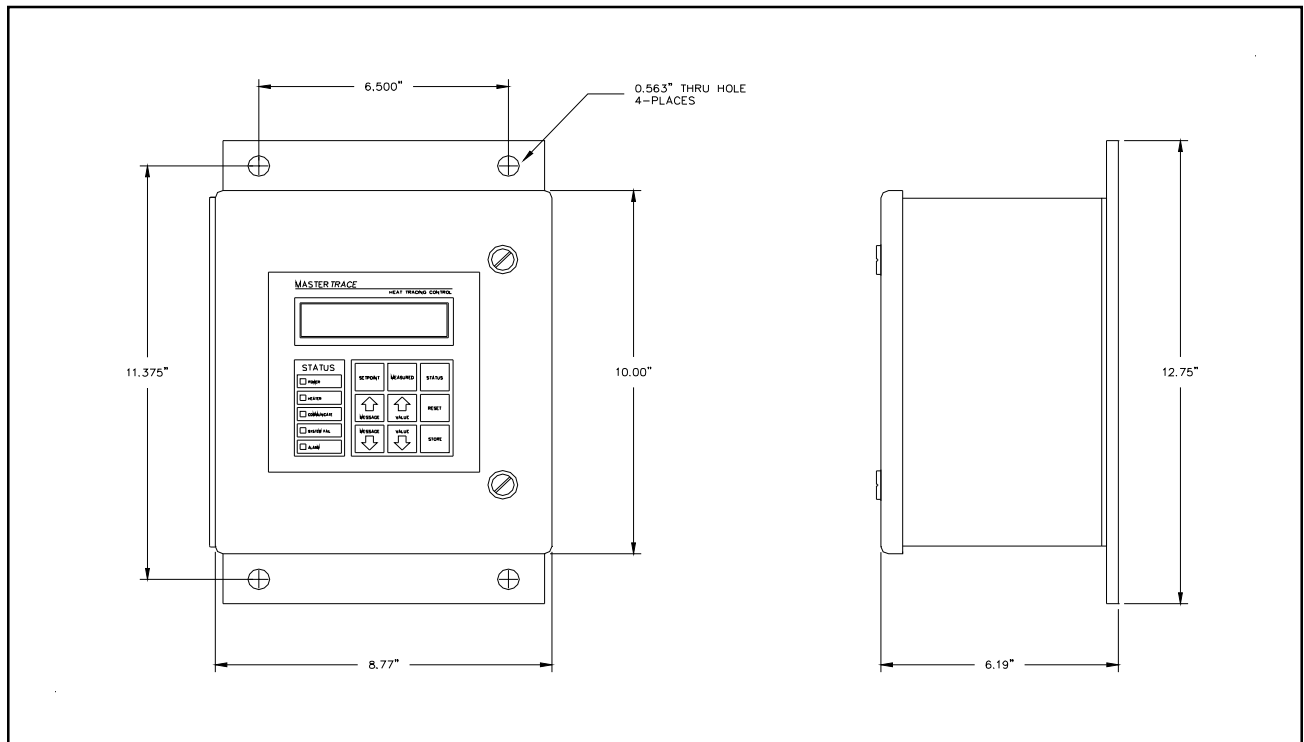
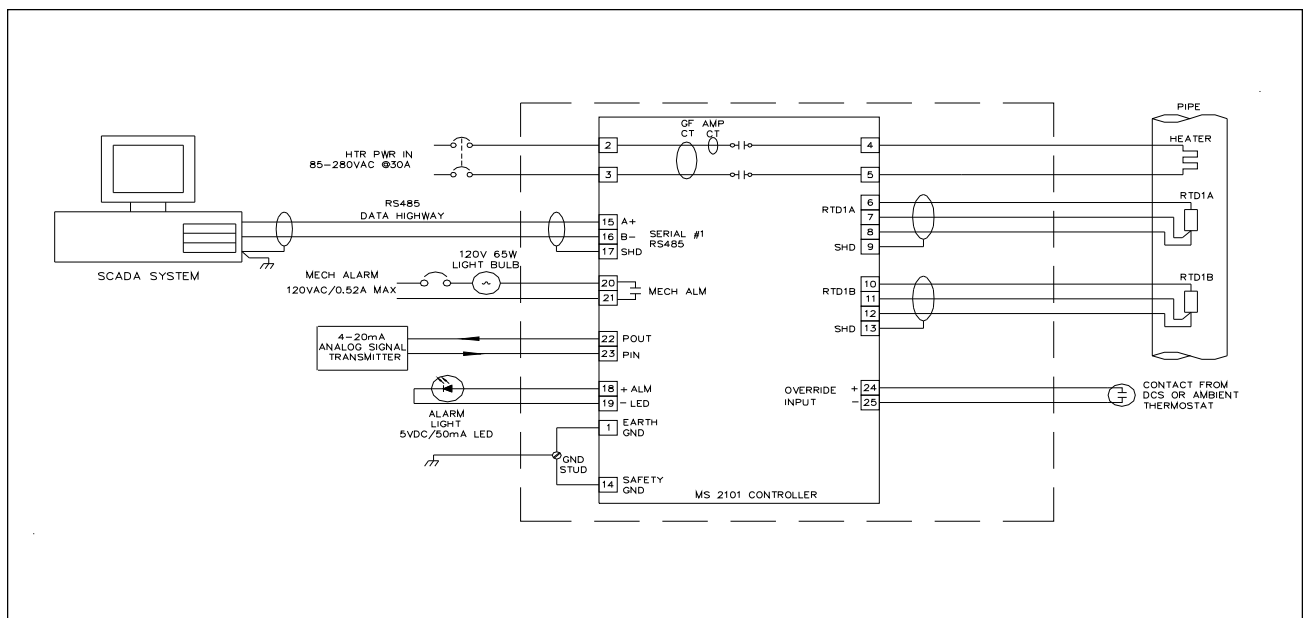

Figure 2.7 Typical Wiring Diagram



Warning - Explosion Hazard - Substitution of components may impair suitability for Class 1, Division 2 or Class 1, Zone 2.



Warning - Explosion Hazard - Do not disconnect equipment unless power has been switched off or the area is known to be non-hazardous.

Introduction

The MS-2101 has many features that provide trouble-free operation of heat tracing installations. An example is presented to illustrate MS-2101 setup and operation on a specific installation. MS-2101 is easy to program and setting up a unit to your specific requirements should be straight forward. In this example, a MS-2101 will control a heavy feed line.

Example: Heater will be programmed as:

Configuration:

- 1) 2 RTDs for temperature sensing
- 2) Mineral insulated (MI) cable is used for the heater.
- 3) Normally open alarm contact to remote programmable control
- 4) Northern climate installation outdoors.
Operating temperatures: -40°~50 °C (LCD:-20°~50 °C)
NEMA-4X weatherproof enclosure.

Setpoint	Required	Range
Fluid maintain temperature	50 °C	-50 to 500°C/off /none
Low temperature alarm	35 °C	-50 to 500°C/off
High temperature alarm	no alarm	-50 to 500°C/off
Nominal heater current	5 amps	0.0 to 60.0A
Nominal heater voltage	115 VAC	100 to 300 Vac
Ground fault trip current	30 mA	10 to 1000mA
Ground fault alarm current	20 mA	10 to 1000mA /off
System exercise time interval	8 hours	1-24/off
Cost per Kilowatt hour	\$0.06	\$0.01-\$0.50
Heater name	HEAVY OIL LINE	16 characters

Install and commission the control in the following order:

- STEP 1: Enabling the heater
- STEP 2: Entering setpoints
- STEP 3: Testing heater and alarms
- STEP 4: Monitoring system status

Enabling the Heater

To enable the heater circuit,

- 1. Press [SETPOINTS] once to access the Setpoints Operating Values group of messages.
- 2. Press [MESSAGE ↵] until the following message appears:



- 3. Press [VALUE ↑] or [VALUE ↓] keys to toggle Heater Enabled between **YES** and **NO**.
- 4. When **YES** is displayed, press [STORE].

Now that the heater circuit is enabled, we can program setpoints for each control.

Entering Setpoints

Accessing the Program: Since the heater control display and keypad are normally accessible to passers-by who may wish to read measured values, a program disable feature is used to prevent accidental changes to the setpoints. So before any setpoints can be entered, the PROGRAM ENABLE dip switch (located on the bottom of the board behind the enclosure door) or PROGRAM ACCESS function (SETPOINT\SYSTEM SETUP\PROGRAM ACCESS) must be set in the ENABLE position.

When programming is complete, set the PROGRAM ENABLE dip switch and PROGRAM ACCESS function to **DISABLE** to prevent accidental changes to the setpoint.

If you try to store a setpoint without the dip switch or PROGRAM ACCESS function in the **ENABLE** setting, the setpoint will not be saved and this message will flash on the screen:



Now that the MS-2101 control is ready for programming, I enter the setpoints for this example. For further information about the organization of all the messages or for details on the range and application of each message see

Chapter 6 Setpoint Values. It is not necessary to enter setpoints in any particular order and any setpoint can be changed later.

Entering Temperature Units °C/°F: Temperature values can be displayed in degrees Celsius or Fahrenheit. To enter values in preferred units, enter this selection first.

To enter temperature units,

1. Press [SETPOINTS] 3 times for System Setup mode and [MESSAGE ↵] 5 times until the following message is displayed:

TEMPERATURE
UNITS: Celsius

2. Press [VALUE ↑] or [VALUE ↓] to toggle selection between Celsius and Fahrenheit.
3. When Celsius is displayed press [STORE]. A brief message appears:

SETPOINT
STORED

Then the message reverts back to the previously entered value for verification. If instead you get the message:

NOT STORED -
PROG DISABLED

the PROGRAM ENABLE dip switch or PROGRAM ACCESS function has not been set to the ENABLE setting. This must be done to proceed with setpoint programming.

Assuming the setpoint was stored, all values will be displayed in °C. Temperature values can automatically be converted to °F at any time by selecting Fahrenheit using this message.

TEMPERATURE
UNITS: Celsius

ASSIGNING HEATER NAME: To assist operators in troubleshooting, you can program each MS-2101 control with a heater name. You can assign up to 16 characters to the name of the heater.

To assign a heater name,

1. Press [SETPOINTS] twice to enter the Heater Setup group of setpoints.
2. Press the [MESSAGE ↵] key until the heater name message appears:

HTR NAME:
NONAME

Note: The heater default name when MS-2101 is shipped from the factory is “NONAME”.

You can program each letter separately with upper and lower case characters, numbers, space or the special symbols !@#\$%^&*()?.,”’;}] [. Uppercase characters are generally more legible. For this example the name has arbitrarily been chosen as:

HEAVY OIL LINE

(The cursor appears under the first letter N in “NONAME”).

3. Press and hold down [VALUE ↑] or [VALUE ↓] until the desired letter you want appears above the cursor, then press [STORE].
4. Press [STORE] to save the current letter displayed and advance the cursor to the next letter.

For Example:

H: Press [VALUE ↑] or [VALUE ↓] until H appears. Press [STORE]. The letter H now appears in the first character position and the cursor is under the second character.

E: Press [VALUE ↓] until E appears. Press the [STORE]. The first 2 letters are now HE and the cursor is under character position 3.

HTR NAME:
HENAME

5. Continue entering each letter this way until the complete new name is displayed.
6. With the cursor under the last character position at the right edge of the message screen (blank character), press [STORE] until the cursor is at the end of the line. A brief message will flash:

NAME
STORED

followed by the new name that has been stored:

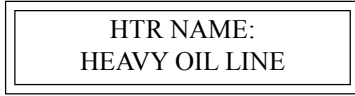

The new heater name is now saved in non-volatile memory and will remain until you change it.

If a character is accidentally entered incorrectly,

1. Either press [RESET] to start over, or go to the end of the line to save the displayed message with the error.
2. Press [MESSAGE ⬆] or [MESSAGE ⬇] to exit and return to the 1st character position.
3. Press [STORE] until the cursor is under the incorrect character. Proceed as before until new letters are entered.
4. Press [STORE] to skip over the correct letters until on the last character position.
5. Press [STORE] to save the corrected message.

You can now enter setpoint information for the system configuration and data for the heater. Turn to *Chapter 6 Setpoint Values*. Read the first few pages to see how the messages are organized and get a summary of all setpoints. Skip the latter part of this chapter which gives a detailed description of each message.

ENTERING SETPOINT TEMPERATURE:

Set the desired maintained temperature for the fluid in the pipe being traced by this heater temperature setpoint.

To enter the heater setpoint,

1. Press [SETPOINT] once to display this message:



2. Press and hold [VALUE ⬆] until 50°C is displayed. Notice that if you press [VALUE ⬆] once, the displayed temperature increments by 1. Holding [VALUE ⬆] causes the displayed value to increment rapidly after a short delay. [VALUE ⬇] works the same way. If you pass the required value, use [VALUE ⬇] to decrease the number displayed.
3. Press [STORE] to save the new value. When a new value is successfully stored a brief acknowledgement message will flash on the screen:



In this example, the temperature at which the control will turn on and supply full system voltage to the heater is now set to 50 °C.

4. Press [MESSAGE ⬇] after each setpoint to access the next setpoint.
5. Hold [VALUE ⬆] down until the word OFF appears to defeat any setpoint not required. For example, if a high current alarm is not required, set the value to off. A detailed description of each message is found in *Chapter 6 Setpoint Values*.

Testing Heater & Alarms

You can force heater and alarm outputs on using the test mode. Like setpoints, this mode requires that the PROGRAM ENABLE dip switch or PROGRAM ACCESS function be set to ENABLE or when you try to store a test value a message will flash:



Testing a Heater:

To test operation of a heater, it can temporarily be forced on.

1. Press [SETPOINT] 4 times.
2. Press [MESSAGE ⬇] until the message appears:



3. Press and hold [VALUE ⬆] or [VALUE ⬇] to set the **ON** time in hours. The range is **DISABLED/1-24 hours/ON-CONTINUOUSLY**. For example, to turn on the heater for one hour, press [VALUE ⬆] to display '1 hour' then press [STORE]. The heater will be energized no matter what the heater temperature setpoint is unless there is a ground fault trip. After the selected time period the heater will automatically go off. While the heater is on, the front panel **HEATER ON** indicator will be illuminated. To override the test mode, press [VALUE ⬇] until **DISABLE** appears and then store this value. Holding the [VALUE ⬆] key until the word **ON CONTINUOUSLY** appears leaves

the heater always energized until the MS-2101 controller is manually powered off or until this setpoint is set to **DISABLE**. Consequently, selecting a value of **ON CONTINUOUSLY** should be used with caution since it overrides normal control operation and could lead to excessive heating or waste power if accidentally left on. A warning message appears in the status mode (press status key to enter status mode) whenever a heater or alarm is forced on.

4. Press [STORE] to save the value.
5. With the heater forced on, verify that the expected current is flowing using the actual current message, located in ACTUAL\OPERATING VALUES\HEATER CURRENT. You can use a clamp-on ammeter attached to one of the heater wires to compare readings. With proportional control selected, the readings may differ due to harmonics in the current waveform. As a safeguard, the heater will automatically timeout after the selected time and go back to automatic operation.

Testing Alarms: The manual alarm setpoint works exactly like the manual heaters setpoint except that it energizes the output alarm and indicator. This setpoint is useful for commissioning a new system or checking alarm circuits. Normally this setpoint will be DISABLED.

Monitoring System Status

Now that the MS-2101 controller has been programmed for a specific application, you can check system status. If no keys are pressed for the time specified in DISPLAY TIMEOUT message located in SETPOINT\SYSTEM SETUP\DISPLAY TIMEOUT, the display will automatically go into the default message mode. **System Status** mode is recommended; that is, the display will automatically display all alarms. If desired, you can change this to a specific message later by reprogramming the default message.

Access actual values by pressing [MEASURED]. These are divided into 2 groups. Pressing [MEASURED] once accesses the group of messages that show current values of temperature, current, etc. Pressing [MEASURED] twice displays the statistics data such as minimum/maximum temperature, power consumption, running hours etc. Unlike setpoints, you cannot change actual values using [VALUE \uparrow], [VALUE \downarrow] or [STORE].

There is a summary of all Measured Values messages at the beginning of *Chapter 5 Measured Values*. To view the actual values,

1. Press [MEASURED].
2. Press [MESSAGE \downarrow] to view each actual value.
3. Continue examining each value of interest by pressing the [MESSAGE \downarrow] key and referring to *Chapter 5 Actual Values*.

Monitoring Heater Temperature

To monitor the heater temperature,

1. Press [MEASURED] once to display:

CONTROL TEMP: 55 °C

This is the temperature value that the controller will use with the heater setpoint to determine the heater output. The MS-2101 calculates the control temperature from the actual temperature of RTD1A and RTD1B (if used) based on the RTD DEFINITION setting (SETPOINT\HEATER SETUP\RTD DEFINITION). Using only one RTD, you must place the RTD probe at a location that best represents the average pipe temperature. However, fluid temperature will vary somewhat along the pipe. Using two RTDs and RTD DEFINITION set to **TWO RTDs AVERAGED** eliminates this problem. If no RTD sensor is connected or a lead is broken the value **OPEN RTD** appears. This is an alarm condition.

When the temperature falls below the heater setpoint, 50 °C in our example, MS-2101 switches on to supply power to the heater. It stays on until the temperature rises above the heater setpoint (50 °C). Once the system has been running for a few hours, the heater temperature should be at or above this setpoint value.

If hot fluid is being pumped through the pipe, the measured temperature may be much higher than the setpoint temperature. But in this case, no power should be supplied to the heater and the **HEATER ON** indicator will be off.

If the heater temperature is less than the minimum display value (-50 °C/-58 °F), the word **RTD FAIL** appears. If the temperature is over the maximum value (+ 500 °C / 932 °F), the maximum value (i.e. 500 °C) will be shown. If an abnormal value appears, particularly on a new installation, check that the correct RTD sensor type has been installed (100 OHM platinum DIN 43760) and that the three RTD wires are wired to the correct terminals.

Monitoring Actual Current:

To monitor the actual current,

1. Press [MEASURED].
2. Press [MESSAGE ↵] 5 times to display:

HEATER CURRENT
5.5 A

This value is the actual measured current of the heater. Resolution is to 0.1 amp over a range of 0.0 to 60.0 amps. Above 60.0 amps the value displayed reads O.L (Overload).

With MI (Mineral Insulated) cable used in this example, it will either be 0.0 if the heater is not energized or a fairly constant current such as 5.0 amps.

Monitoring Ground Fault Current: Some stray current always flows to ground due to capacitance effects and leakage.

To monitor ground fault current,

1. Press the [MESSAGE ↵] key from the heater voltage message
or
Press [MEASURED] then [MESSAGE ↵] 6 times to display:

GROUND FAULT
CURRENT: 15 mA

In this example, any value above 20 mA would cause an alarm and if a ground fault current above 30 mA were detected, MS-2101 would remove power to the heater. If the heater is off, the value displayed would be 0. For values over 15 mA, check the system for insulation leakage problems.

You have now checked all actual values.

Viewing Statistical Data: In addition to actual values that are present, such as current and temperature, the MS-2101 continuously gathers and computes historic information about the heat tracing system to determine cost of operation, utilization, trends etc. This can be quite useful in spotting potential problems or in designing similar systems for other applications. Data is saved indefinitely but you can clear it anytime.

To view statistical data,

1. Press [MESSAGE ↵] from the actual value messages just displayed to take you to the statistics values group
or

Press [MEASURED] twice to display the first message in this group. Either way displays a brief message to indicate the start of the statistics page followed by the first value message:

ACTUAL:
STATISTICS

Since this is a new installation any random data should be cleared.

2. Press [MESSAGE ↵] in this group until the message appears:

RESET STATISTICS:
yes

3. Reset statistics for a new measurement interval. The MS-2101 keeps track of when the measurement interval started. See *Chapter 5 Measured Values* for a complete description of how data is gathered and application ideas.

This completes setpoint programming and system testing. Set the PROGRAM ENABLE dip switch and PROGRAM ACCESS function to DISABLE to prevent accidental setpoint changes or tampering. By following this procedure, it should be fairly easy to install a similar control application. More details about each message is provided in *Chapter 5* and *Chapter 6*.

As you use the system, some setpoints may need adjusting. For example, frequent low temperature alarms might indicate that the setpoint value was set too close to normal heater temperature swings and needs to be lowered. Once the system has been operating normally for a while an alarm will indicate a change that needs investigation.

The flexibility and many features of the MS-2101 system significantly reduces problems caused by heat tracing malfunctions.

Overview

The front panel provides the local operator with LCD alphanumeric display and keypad. The display and status indicators update alarm and status information automatically. The keypad is used to select the appropriate message for entering setpoints or displaying Measured Values.

The 32 character, backlit, LCD display provides English messages that are visible under various lighting conditions. When the display and keypad are not being used, the screen displays system information, which is definable through three user selected default messages. These default messages only appear after a user defined period of inactivity. Press either [SETPOINT], [MEASURED] or [STATUS] to override the default messages.

Operating the Keypad

The MS-2101 display messages are organized into pages under headings **Setpoints** and **Measured Values**.

- [SETPOINT]: Provides entry to the Setpoint Menu which allows you to navigate through user settable parameters. See *Chapter 6 Setpoint Values* for detailed messages.
- [MEASURED]: Provides entry to the Measured Values Menu which you to navigate through measured parameters.
- [STATUS]: Provides immediate access to the System Status Menu which displays the alarm status for the Controller and allows access to individual alarm details.
- [MESSAGE \uparrow]: Allows you to move up through the selected menu.
- [MESSAGE \downarrow]: Allows you to move down through the selected menu.
- [VALUE \uparrow]: Allows you to increase the value of the displayed selected item.
- [VALUE \downarrow]: Allows you to decrease the value of the displayed selected item.
- [STORE]: Allows you to save the changed value of the selected item.
- [RESET]: Allows you to clear alarms that are no longer active.

Status Lights

Refer to *Figure 4.1 Display, Front View*.

- **L10 Power:** The green **Power** light should be on at all times indicating that control power is applied to the Module. If the light is off, either there is no control power or the display has a malfunction and requires servicing.
- **L11 Heater:** The green **Heater** light is on if the heater is energized.
- **L12 Communicate:** Random flashing of the green **Communicate** light indicates that serial communications are active on the controller.
- **L13 System Fail:** The red **System Fail** light should be off, indicating that the system check was successful.
- **L14 Alarm:** The red **Alarm** light is off when there are no alarms. The light flashes if any alarm conditions are present. Press [STATUS] to view alarms.

Alphanumeric Display

Refer to *Figure 4.1 Display, Front View*.

- **D10 Display:** Two lines with 16 alphanumeric characters per line. It is backlit for viewing in low-light conditions.

Keypad

Refer to *Figure 4.1 Display, Front View*.

- **K10 Display Keypad:** Consists of nine keys which, when used in connection with the Alphanumeric Display, allow complete control of programming and monitoring of the Control Module.

Display Contrast

Refer to *Figure 4.2 Contrast Control*

- **P1 LCD display:** After the MS-2101 is field mounted, it may be necessary to adjust the display contrast to compensate for the viewing angle. To adjust the contrast, open the enclosure door and locate the potentiometer (labelled **DISPLAY CONTRAST** pot) on the board attached to the enclosure door. Turn the set-screw clockwise or counter-clockwise until the display is desirable.

Heater Numbering

Each heater is identified by a number of the form “M-1”, where “M” is the Module Number. Each Controller on the same data highway must have a unique Module Number.

Figure 4.1 Display, Front View

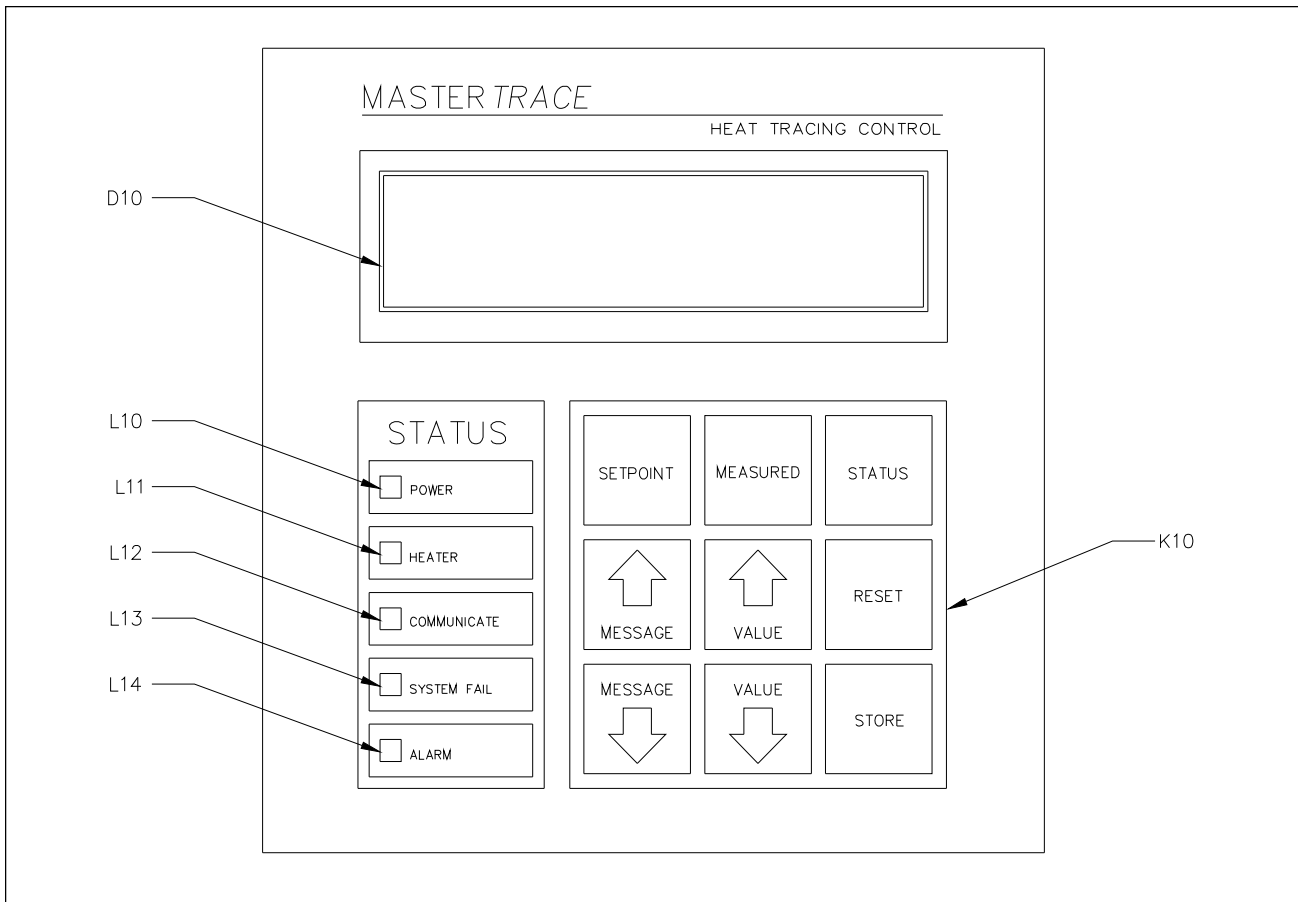
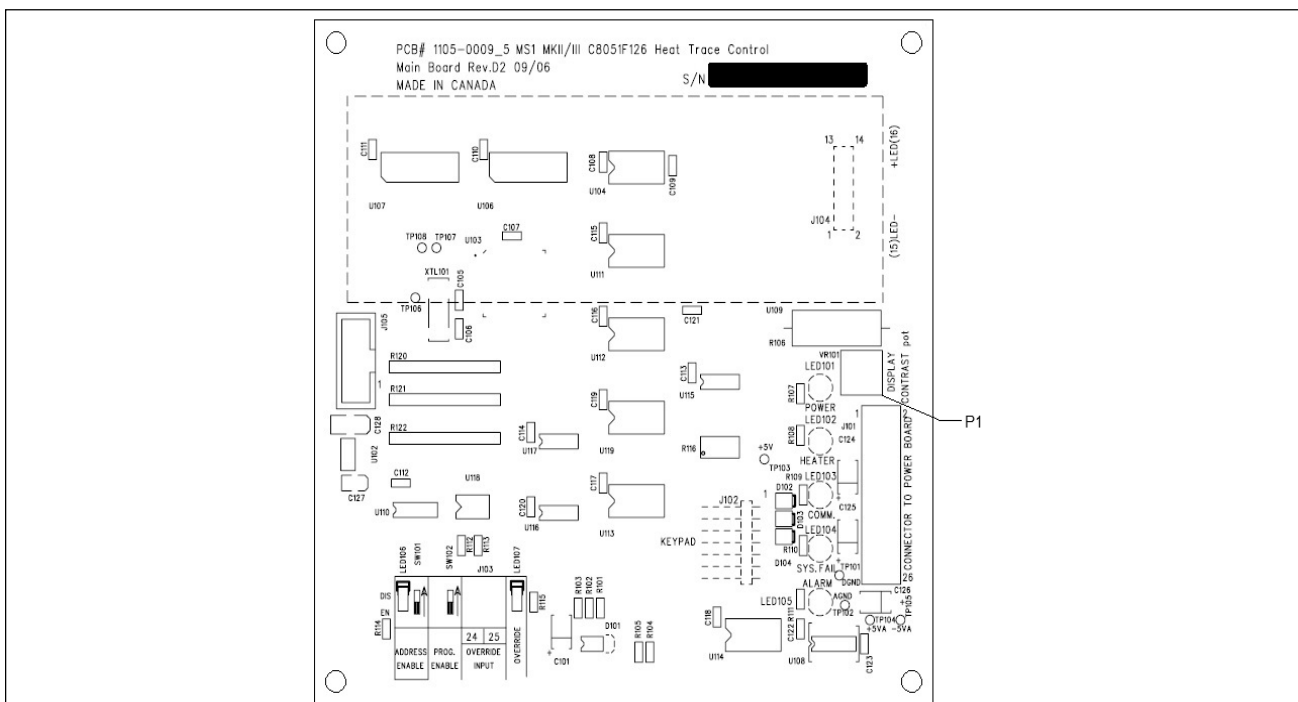

Figure 4.2 Contrast Control



Startup Messages

Startup messages are displayed when power is applied to the controller.

SELF CHECKING..	This message appears when the controller is powered-up and executing self-diagnostic functions.
MASTERTRACE HEAT TRACING CONTROL	This message displays the controller model.
NEXTRON CORPORATION	This message displays company name of the supplier.
FIRMWARE VERSION D2-02-00	This messages displays the firmware version number.
SELF CHECK PASSED	This message appears when the controller has successfully completed execution of self-diagnostic functions.
SELF CHECK FAILED	This message appears when the controller has detected faults during self-diagnostic function execution or normal operation. This may be as result of memory or CPU failure. The controller requires servicing.

Status Messages

Status messages are automatically displayed for any active conditions in the controller such as trips and alarms. These messages provide an indication of the

current state of the controller.

Some messages prompt you to press [MESSAGE ↵] to scroll through messages to provide additional details of the controller status.

SYSTEM OK NO ALARMS	This message indicates there are no alarms present.
2 ALARMS PRESS MESSAGE DOWN	This message indicates the number of alarms on the controller. Press [MESSAGE ↵] to locate the problem and the cause.
PRESS MESSAGE DOWN FOR NEXT ALARM	This message marks the end of details to an alarm. Pressing [MESSAGE ↵] to scroll through details of the next alarm.

NO MORE ALARMS

This message appears when the user has scrolled through all alarms.

Flash Messages

Flash messages are warnings, errors or general information displayed in response to a key press. The duration of

the message can be configured in SETPOINTS\SYSTEM SETUP\SCAN TIME. The factory default is three seconds.

SETPOINT STORED

This message appears when a setpoint has been stored.

PRESET DISABLED
ALARM ACTIVE

This message indicates that the alarm cannot be reset because the alarm condition is still present.

NAME STORED

This message appears when the heater name has been stored.

NOT STORED
PROG DISABLED

This message indicates that the program enable dip switch or program access function is set to disable and programming is not allowed. Refer to *Chapter 6, Section 6.3*, for details on Setpoint Access Security.

Overview

Access values and statistics in the Measured Values mode. The messages are organized into groups for easy reference as shown below. Throughout this chapter each group is detailed by section.

[MEASURED] provides access to the Measured Values Menu which allows the user to display the Measured

Values of the control modules.

The Measured Values Menu is arranged in two groups. Pressing [MEASURED] twice quickly access the top of the second group. [MESSAGE ↑] allows you to move up through the selected menu. [MESSAGE ↓] allows you to move down through the selected menu.

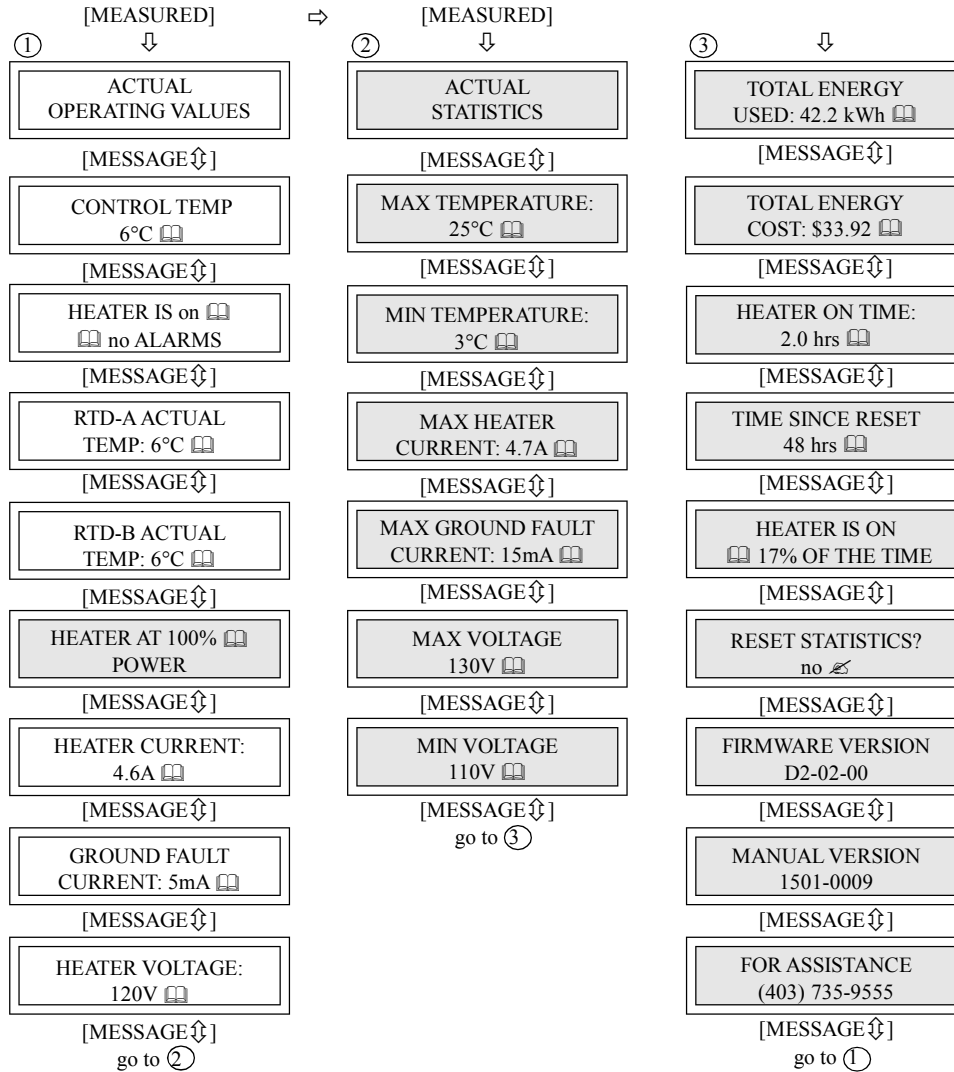

Restrictions

 Advanced User Mode

Operating

MEASURED:
OPERATING VALUES

MESSAGE NO: M1-01 APPLIES TO: Control Module
 DEFAULT VALUE: N/A VALUE RANGE: N/A
 DISPLAY MODE: All RESTRICTIONS: None
 This message displays the name of the sub-menu when entered.

CONTROL TEMP:
6°C

MESSAGE NO: M1-02 APPLIES TO: Selected Heater
 DEFAULT VALUE: N/A VALUE RANGE: -50 to 500 °C, RTD Open
 -58 to 932 °F, RTD Fault
 DISPLAY MODE: All RESTRICTIONS: Heater Setpoint must not be
 off or **none**.

MS-2101 calculates the displayed value the actual measured temperatures of both RTD sensors based on the RTD DEFINITION function. MS-2101 controls the heater circuit by comparing the Heater Control Temperature to the Heater Setpoint. If the temperature is outside the value range, then **RTD OPEN** or **RTD FAULT** is displayed.

HEATER IS on
 no ALARMS

MESSAGE NO: M1-03 APPLIES TO: Selected Heater
 DEFAULT VALUE: N/A VALUE RANGE: on, off, man on,
 no: 1 to 9 alarms

DISPLAY MODE: All RESTRICTIONS: None

The displayed value is the status of the heater. It indicates whether the heater circuit is on or off and the number of alarm messages associated with the circuit. The heater is forced on by HEATER TEST function if **man on** is displayed. See HEATER TEST function.

RTD-A ACTUAL
TEMP: 6°C

MESSAGE NO: M1-04 APPLIES TO: Selected Heater
 DEFAULT VALUE: N/A VALUE RANGE: -50 to 500 °C, RTD Open
 -58 to 932 °F, RTD Fault
 DISPLAY MODE: All RESTRICTIONS: Heater Setpoint must not be
 off .

The displayed value is the actual measured temperature of RTD-A sensor . It calculates the Heater Control Temperature based on the RTD DEFINITION function. If the temperature is outside the value range, then “**RTD OPEN**” or **RTD FAULT** is displayed.

RTD-B ACTUAL
TEMP: 6°C

MESSAGE NO: M1-05 APPLIES TO: Selected Heater
 DEFAULT VALUE: N/A VALUE RANGE: -50 to 500 °C, RTD Open
 -58 to 932 °F, RTD Fault
 DISPLAY MODE: All RESTRICTIONS: Heater Setpoint must not be
 off . RTD Definition must not be **1 RTD**.

The displayed value is the actual measured temperature of RTD-B sensor. It calculates the Heater Control Temperature based on the RTD DEFINITION function. If the temperature is outside the value range then, **RTD OPEN** or **RTD FAULT** is displayed.

MIN TEMPERATURE:
3°C

MESSAGE NO: M2-03 APPLIES TO: Selected Heater
 DEFAULT VALUE: N/A VALUE RANGE: -50 to 500 °C
 -58 to 932 °F, RTD Fault
 DISPLAY MODE: Advanced RESTRICTIONS: Heater Setpoint must not be **off**.

The displayed value is the lowest Measured Temperature since the last reset. If the displayed value is **RTD FAULT**, a value less than the minimum range was recorded. To reset the displayed value press [RESET]. To reset with all statistics, use RESET STATISTICS.

MAX HEATER CURRENT
4.7A

MESSAGE NO: M2-04 APPLIES TO: Selected Heater
 DEFAULT VALUE: N/A VALUE RANGE: 0.1 to 60.0 A, O.L.
 DISPLAY MODE: Advanced RESTRICTIONS: None

The displayed value is the highest Heater Current since the last reset. If the displayed value is **O.L.**, a value greater than the maximum range was recorded. To reset the displayed value, press [RESET]. To reset with all statistics, use RESET STATISTICS.

MAX GROUND FAULT
CURRENT: 15mA

MESSAGE NO: M2-05 APPLIES TO: Selected Heater
 DEFAULT VALUE: N/A VALUE RANGE: 0, 10 to 1000 mA,O.L.
 DISPLAY MODE: Advanced RESTRICTIONS: None

The displayed value is the highest Ground Fault Current since the last reset. If the displayed value is **O.L.**, a value greater than the maximum range was recorded. To reset the displayed value, press [RESET]. To reset with all statistics, use RESET STATISTICS.

MAX VOLTAGE:
130V

MESSAGE NO: M2-06 APPLIES TO: Selected Heater
 DEFAULT VALUE: N/A VALUE RANGE: 85 to 300 V, O.L.
 DISPLAY MODE: Advanced RESTRICTIONS: None

The displayed value is the highest Heater Voltage since the last reset. If the displayed value is **O.L.**, a value greater than the maximum range was recorded. To reset the displayed value, press [RESET]. To reset with all statistics, use RESET STATISTICS.

MIN VOLTAGE:
110V

MESSAGE NO: M2-07 APPLIES TO: Selected Heater
 DEFAULT VALUE: N/A VALUE RANGE: 85 to 300 V, O.L.
 DISPLAY MODE: Advanced RESTRICTIONS: None

The displayed value is the lowest Heater Voltage since the last reset. If the displayed value is "O.L.", a value less than the minimum range was recorded. To reset the displayed value press [RESET]. To reset with all statistics use RESET STATISTICS function.

TOTAL ENERGY
USED: 42.2kWh

MESSAGE NO: M2-08 APPLIES TO: Selected Heater
 DEFAULT VALUE: N/A VALUE RANGE: 0 to 1000 MWh
 DISPLAY MODE: Advanced RESTRICTIONS: None

The displayed value is the energy used since the last reset. Energy is calculated from the Heater Current times the Heater Voltage integrated over time. If the displayed value is **O.L.**, a value greater than the maximum range was recorded. To reset, use RESET STATISTICS.

TOTAL ENERGY
COST: \$33.92 

MESSAGE NO: M2-09 APPLIES TO: Selected Heater
 DEFAULT VALUE: N/A VALUE RANGE: \$0 to \$100,000.00
 DISPLAY MODE: Advanced RESTRICTIONS: None
 The displayed value is the energy cost since the last reset. Energy cost is calculated from the Energy Used times the COST PER kWh. To reset, use RESET STATISTICS.

HEATER ON TIME
80 hrs 

MESSAGE NO: M2-10 APPLIES TO: Selected Heater
 DEFAULT VALUE: N/A VALUE RANGE: 0 to 999,999 hours
 DISPLAY MODE: Advanced RESTRICTIONS: None
 The displayed value is the accumulated time that the heater circuit has been on since the last reset. It indicates how active the heater circuit is and can be useful for maintenance. To reset, use RESET STATISTICS.

TIME SINCE RESET
48 hrs 

MESSAGE NO: M2-11 APPLIES TO: Control Module
 DEFAULT VALUE: N/A VALUE RANGE: 0 to 999,999 hours
 DISPLAY MODE: Advanced RESTRICTIONS: None
 The displayed value is the total time since last reset. It is useful for maintenance purposes. To reset, use RESET STATISTICS.

HEATER IS ON
 17% OF THE TIME

MESSAGE NO: M2-12 APPLIES TO: Selected Heater
 DEFAULT VALUE: N/A VALUE RANGE: 0 to 100%
 DISPLAY MODE: Advanced RESTRICTIONS: None
 The displayed value is the percentage of time that the heater circuit has been on since the last reset. $\text{PERCENT ON TIME} = \text{HEATER ON TIME} \div \text{TIME SINCE RESET} \times 100\%$. It indicates how active the heater circuit is and can be useful for maintenance. Interpretation of this value depends on the process but large changes could be an indication of degradation of the heater or the insulation. To reset, use RESET STATISTICS.

RESET STATISTICS?
no 

MESSAGE NO: M2-13 APPLIES TO: Control Module
 DEFAULT VALUE: N/A VALUE RANGE: yes, no
 DISPLAY MODE: Advanced RESTRICTIONS: None
 This function resets all the statistical values. Select **yes** and then press [STORE]. You are asked to confirm your request. Again, select **yes** and then press [STORE]. The statistical values are now cleared.

ARE YOU SURE?
no 

FIRMWARE VERSION
D2-02-00

MESSAGE NO: M2-14 APPLIES TO: Control Module
 DEFAULT VALUE: N/A VALUE RANGE: N/A
 DISPLAY MODE: Advanced RESTRICTIONS: None
 This message displays the firmware version number.

MANUAL VERSION
1501-0009

MESSAGE NO: M2-15 APPLIES TO: Control Module
DEFAULT VALUE: N/A VALUE RANGE: N/A
DISPLAY MODE: Advanced RESTRICTIONS: None
This message displays the operation manual revision and reorder number.

FOR ASSISTANCE
(403) 735-9555

MESSAGE NO: M2-16 APPLIES TO: Control Module
DEFAULT VALUE: N/A VALUE RANGE: N/A
DISPLAY MODE: Advanced RESTRICTIONS: None
This message displays the factory telephone number.

Overview

The MS-2101 has a considerable number of programming setpoints for flexibility. Setpoint messages are organized into groups for easy reference as shown below. Throughout this chapter each group is detailed by section. [SETPOINT] provides entry to the Setpoint Menu which

allows you to program and test the Control Module. The Setpoint Menu is arranged in four groups. Pressing [SETPOINT] twice quickly to access the top of the second group; press three times to access the top of the third group, and so on.

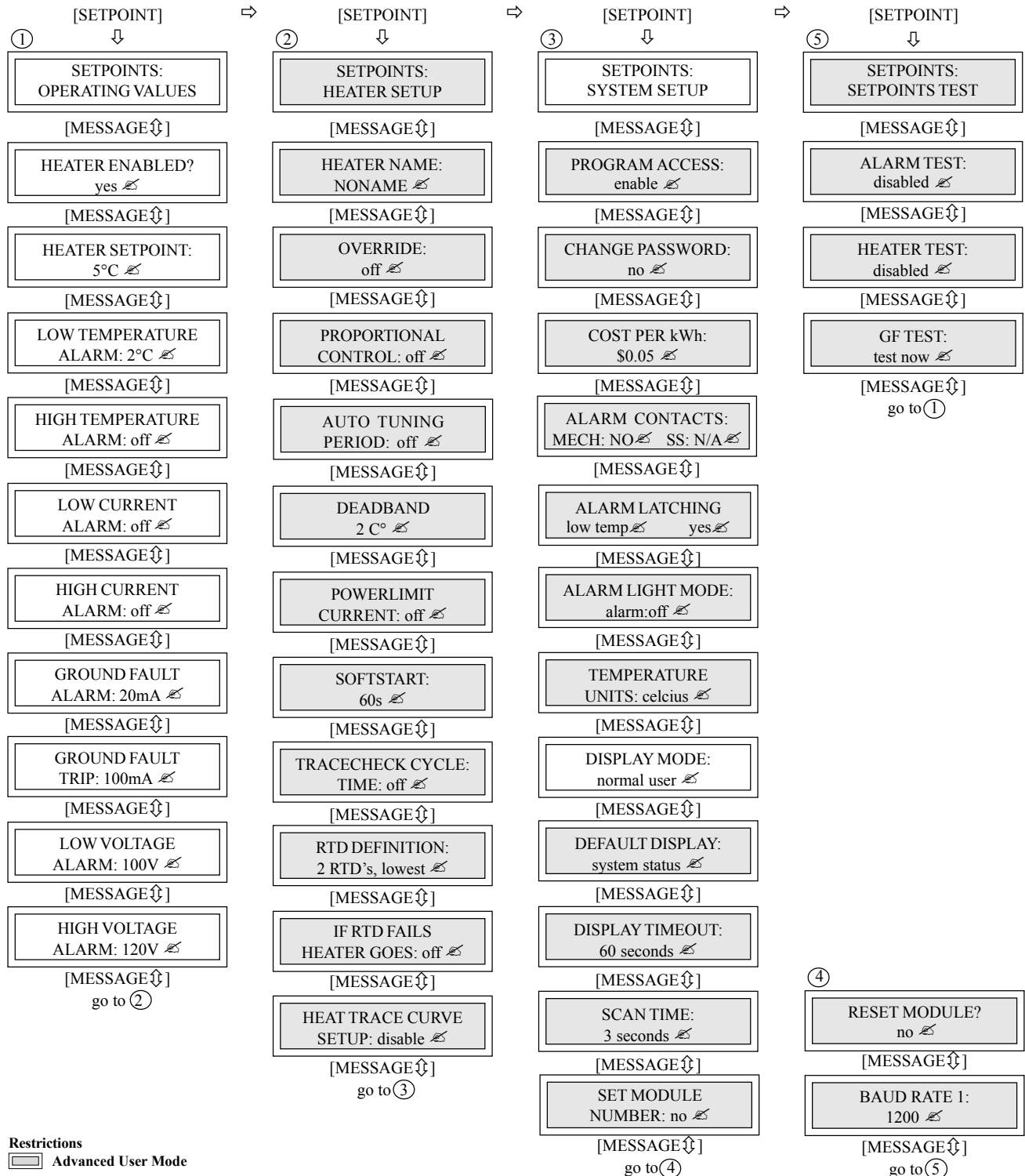

Setpoints Entering

Prior to operating the heat trace, you must enter process setpoints, alarm levels and alarm output configuration via front panel keypad and display, RS485 port or SCADA system running user written software.

The MS-2101 leaves the factory with default setpoint values shown in the message details. You can leave many



Warning: As a minimum, enter setpoints in the operating values group (S1) to ensure proper operation of the heat trace.

of the factory default settings unchanged.

Setpoint Access Security

The controller has hardware and software security features designed to protect against unauthorized setpoint

changes. The two security functions operate in an “OR” logic such that one can override the other.

Using the Program Enable Dip Switch

If program access in the system setup is disabled, you can program setpoints through the keypad by setting the program enable dip switch to the enable position. Access the dip switch by opening the enclosure door and locating the switch at the bottom of the board on the enclosure door. When setpoint programming is complete, return the dip switch to the disable position. Disabling program enable does not restrict setpoint access through the communications.

Using a Program Access Password

You can use the programmable password to prevent program access from being enabled. The password consists of four key strokes. The default setting is no password. Without a password, any user can enable program access and make changes to the setpoints from the keypad. When program access is disabled, you can gain setpoint access to the keypad by setting the program enable dip switch to the enable position. Disabling program access does not restrict setpoint access through the communications.

Operating

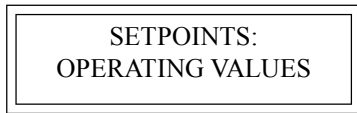

MESSAGE NO: S1-01 APPLIES TO: Interface Module
 DEFAULT VALUE: N/A VALUE RANGE: N/A
 DISPLAY MODE: All RESTRICTIONS: None
 This message displays the name of the sub-menu when entered.

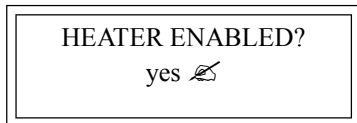

MESSAGE NO: S1-02 APPLIES TO: Selected Heater
 DEFAULT VALUE: yes VALUE RANGE: yes, no
 DISPLAY MODE: All RESTRICTIONS: None
 This function enables control and monitoring for the heater circuit. You cannot access setpoints and measured value messages unless the heater is enabled. Select **no** if the circuit is not used.

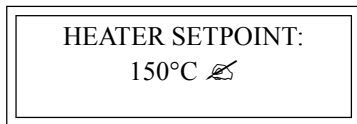

MESSAGE NO: S1-03 APPLIES TO: Selected Heater
 DEFAULT VALUE: 20 °C VALUE RANGE: -50 to 500 °C, none, off
 68 °F -58 to 932 °F, none, off
 DISPLAY MODE: All RESTRICTIONS: None
 This function sets the maintain temperature. For on-off control, the circuit is energised if the Heater Control Temperature is less than the Heater Setpoint less the deadband. The circuit is de-energised if the Heater Control Temperature is greater than the Heater Setpoint plus the deadband. Both the PROPORTIONAL CONTROL and the POWER LIMIT functions affect heater switching. If the Heater Setpoint is set to **none**, then the heater circuit is on and has temperature monitoring with no temperature control. If the Heater Setpoint is set to **off** then the heater circuit is on and has no temperature monitoring or control.

<p>LOW TEMPERATURE ALARM: 120°C </p>

MESSAGE NO: S1-04	APPLIES TO: Selected Heater
DEFAULT VALUE: 5°C 41°F	VALUE RANGE: -50 to 500 °C, off -58 to 932 °F, off
DISPLAY MODE: All	RESTRICTIONS: Heater Setpoint must not be off .

This function sets the Low Temperature Alarm setpoint. *It must be less than the Heater Setpoint.* To disable this alarm, set the value to **off**. When the Heater Control Temperature is less than or equal to this setpoint, the Low Temperature Alarm is activated and a **LOW TEMPERATURE ALARM** message is added to the System Status messages. The alarm deactivates when the temperature rises above this alarm setpoint.

<p>HIGH TEMPERATURE ALARM: 130°C </p>
--

MESSAGE NO: S1-05	APPLIES TO: Selected Heater
DEFAULT VALUE: off	VALUE RANGE: -50 to 500 °C, off -58 to 932 °F, off
DISPLAY MODE: All	RESTRICTIONS: Heater Setpoint must not be off .

This function sets the High Temperature Alarm setpoint. *It must be greater than the Heater Setpoint.* To disable this alarm, set the value to **off**. When the Heater Control Temperature is greater than or equal to this setpoint, the High Temperature Alarm is activated and a **HIGH TEMPERATURE ALARM** message is added to the System Status messages. The alarm deactivates when the temperature falls below this alarm setpoint.

<p>LOW CURRENT ALARM: 10.5A </p>

MESSAGE NO: S1-06	APPLIES TO: Selected Heater
DEFAULT VALUE: off	VALUE RANGE: 0.1 to 30.0 A, off
DISPLAY MODE: All	RESTRICTIONS: None

This function sets the Low Current Alarm setpoint. *It must be less than the High Current Alarm setpoint.* To disable this alarm, set the value to **off**. When the Heater Current is less than or equal to this setpoint, the Low Current Alarm is activated and a **LOW CURRENT ALARM** message is added to the System Status messages. The alarm deactivates when the Heater Current rises above this alarm setpoint. The value range is in 0.1 A increments.

Note: This setpoint is based on the heater at 100% power. If Proportional Control or Power Limit is enabled, all current measurements will be converted to 100% power, based on a constant resistive load, before being compared to the alarm setpoint.

HIGH CURRENT
ALARM: 15.0A 

MESSAGE NO: S1-07 APPLIES TO: Selected Heater
DEFAULT VALUE: off VALUE RANGE: 0.1 to 30.0 A, off
DISPLAY MODE: All RESTRICTIONS: None

This function sets the High Current Alarm setpoint. *It must be greater than the Low Current Alarm setpoint.* To disable this alarm, set the value to **off**. When the Heater Current is greater than or equal to this setpoint, the High Current Alarm is activated and a **HIGH CURRENT ALARM** message is added to the System Status messages. The alarm deactivates when the Heater Current falls below this alarm setpoint. The value range is in 0.1 A increments.

Note: High current alarm is disabled when proportional control, powerlimit or softstart functions are operating the heater below 100% duty cycle to prevent erroneous alarms at low duty cycles.

GROUND FAULT
ALARM: 20mA 

MESSAGE NO: S1-08 APPLIES TO: Selected Heater
DEFAULT VALUE: 20 mA VALUE RANGE: 10 to 1000 mA, off
DISPLAY MODE: All RESTRICTIONS: None

This function sets the Ground Fault Alarm setpoint. *It must be less than the Ground Fault Trip setpoint.* To disable this alarm, set the value to **off**. When the Ground Fault Current is greater than or equal to this setpoint, the Ground Fault Alarm is activated and a **GROUND FAULT ALARM** message is added to the System Status messages. The alarm deactivates when the Ground Fault Current falls below this alarm setpoint. The value range is in 1 mA increments.

GROUND FAULT
TRIP: 100mA 

MESSAGE NO: S1-09 APPLIES TO: Selected Heater
DEFAULT VALUE: 30 mA VALUE RANGE: 10 to 1000 mA, off
DISPLAY MODE: All RESTRICTIONS: None

This function sets the Ground Fault Trip setpoint. *It must be greater than the Ground Fault Alarm setpoint.* When the Ground Fault Current is greater than or equal to this setpoint, the heater circuit is opened, the Ground Fault Trip Alarm is activated and a **GROUND FAULT TRIP** message is added to the System Status messages. This is a latching alarm. When the cause of the alarm has been corrected, locate the alarm message in the Status Menu and press [RESET]. The value range is in 1 mA increments.

LOW VOLTAGE
ALARM: 100 V 

MESSAGE NO: S1-10 APPLIES TO: Selected Heater
DEFAULT VALUE: off VALUE RANGE: 85 to 300 V, off
DISPLAY MODE: All RESTRICTIONS: None

This function sets the Low Voltage Alarm setpoint. To disable this alarm, set the value to **off**. When the Heater Voltage is less than or equal to this setpoint, the Low Voltage Alarm is activated and a **LOW VOLTAGE ALARM** message is added to the System Status messages. The alarm deactivates when the Heater Voltage rises above this alarm setpoint.

HIGH VOLTAGE
ALARM: 120 V 

MESSAGE NO: S1-11 APPLIES TO: Selected Heater
DEFAULT VALUE: off VALUE RANGE: 85 to 300 V, off
DISPLAY MODE: All RESTRICTIONS: None

This function sets the High Voltage Alarm setpoint. To disable this alarm, set the value to **off**. When the Heater Voltage is greater than or equal to this setpoint, the High Voltage Alarm is activated and a **HIGH VOLTAGE ALARM** message is added to the System Status messages. The alarm deactivates when the Heater Voltage falls below this alarm setpoint.

Heater Setup

SETPOINTS:
HEATER SETUP

MESSAGE NO: S2-01 APPLIES TO: Interface Module
DEFAULT VALUE: N/A VALUE RANGE: N/A
DISPLAY MODE: Advanced RESTRICTIONS: None

This message displays the name of the sub-menu when entered.

HEATER NAME:
NONAME 

MESSAGE NO: S2-02 APPLIES TO: Selected Heater
DEFAULT VALUE: NONAME VALUE RANGE: 16 Alphanumeric Characters
DISPLAY MODE: Advanced RESTRICTIONS: None

This function sets the Heater Name. It provides a unique, identifiable tag or label for the heater circuit. The Heater Name consists of 16 alphanumeric characters that you enter one at a time from left to right. The cursor indicates which character is being selected. Press [VALUE \uparrow] or [VALUE \downarrow] to change the character. Move to the next character by pressing [STORE]. Continue in this way until all 16 characters are entered. Press [STORE] in the last character position to save the Heater Name.

OVERRIDE:
off 

MESSAGE NO: S2-03 APPLIES TO: Selected Heater
DEFAULT VALUE: off VALUE RANGE: on, off
DISPLAY MODE: Advanced RESTRICTIONS: None

This feature sets the response of the heater circuit to the Override input. The Override input responds to a contact closure. If the Override is set to **off** or the Override inputs are shorted, control of the heater circuit operates normally based on the Control Temperature and the Heater Setpoint. If the Override is set to **on** and the Override inputs are open, the heater circuit is opened regardless of the Control Temperature. If the Heater Setpoint is set to **off** or **none** and the Override is set to **on**, the Override input has full control over the heater circuit. Override inputs from multiple controllers may be connected together in daisy chain fashion to a mechanical contact for load shedding or ambient temperature override.

PROPORTIONAL
CONTROL: off 

MESSAGE NO: S2-04 APPLIES TO: Selected Heater
DEFAULT VALUE: off VALUE RANGE: on, off
DISPLAY MODE: Advanced RESTRICTIONS: Heater Setpoint must not be **off**.

This function minimizes temperature overshoot and undershoot for tighter temperature control. For critical temperature maintenance applications you can obtain more accurate control by using this feature. However, the time to reach Heater Setpoint may be longer. With Proportional Control set to **on**, as the Heater Control Temperature approaches the Heater Setpoint, the percent duty cycle of the heater is reduced. With Proportional Control set to **off**, on-off control is used.

AUTO TUNING
PERIOD: off 

MESSAGE NO: S2-05 APPLIES TO: Selected Heater
DEFAULT VALUE: off VALUERANGE: 1 to 24 hrs, off
DISPLAY MODE: Advanced RESTRICTIONS: Heater Setpoint must not be **off**.

This function sets the Auto Tuning Period. Once the period is set, the controller would automatically adjust its proportional control gain constant based on the system performance data every Auto Tuning Period. The exact value of this Auto Tuning Period depends the inertia time constant of the heat tracing system. The slower the heat tracing system is, the longer the auto tuning period should be. With Auto Tuning Period set to **off**, the auto tuning feature is disabled and the proportional control gain constant stays on a fixed large value.

DEADBAND
5C° 

MESSAGE NO: S2-06 APPLIES TO: Selected Heater
DEFAULT VALUE: 2 C° VALUERANGE: 1 to 50 C°
4 F° 2 to 90 F°
DISPLAY MODE: Advanced RESTRICTIONS: Proportional Control must be **off**. Heater Setpoint must not be **off**.

This feature sets the size of the deadband for on-off control. Decreasing the deadband increases the temperature control accuracy but also increases the heater switching frequency.

POWER LIMIT CURRENT:
20.5A 

MESSAGE NO: S2-07 APPLIES TO: Selected Heater
DEFAULT VALUE: off VALUE RANGE: 0.1 to 30.0 A, off
DISPLAY MODE: Advanced RESTRICTIONS: None

This function sets the maximum average current that flows in the heater circuit. It is useful for limiting the inrush current of self regulating cable or reducing the power output of constant wattage heaters. Set the value below the breaker rating or to the maximum power desired (Wattage = Heater Voltage x Power Limit value). The value range is in 0.1 A increments.

SOFTSTART:
60 s 

MESSAGE NO: S2-08 APPLIES TO: Selected Heater
DEFAULT VALUE: off VALUE RANGE: 10 to 999s, off
DISPLAY MODE: Advanced RESTRICTIONS: none

This function ramps the heater output to nominal current of the heater over the set softstart cycle time during controller startup. It is useful for reducing inrush currents of self-regulating heaters. When softstart is used in conjunction with powerlimit, the maximum current reached is constrained by the Powerlimit Current setting.

TRACECHECK CYCLE
TIME: 4 hours 

MESSAGE NO: S2-09 APPLIES TO: Selected Heater
DEFAULT VALUE: off VALUE RANGE: 1 to 24 hours, off
DISPLAY MODE: Advanced RESTRICTIONS: None

This function sets the frequency at which TraceCheck is activated. TraceCheck is a feature that exercises the system by automatically applying power to the heater if off for about 30 seconds. If an alarm condition is detected during this period, the TraceCheck™ Alarm is activated and a **ALARM DURING TRACECHECK** message is added to the System Status messages. If a ground fault is detected, the heater circuit is opened. This is a latching alarm. To clear the alarm, locate the alarm message in the Status Menu and press [RESET]. To disable this feature, set the value to **off**. TraceCheck™ decreases maintenance by providing an early warning of problems that would otherwise go undetected until the heater was needed.

RTD DEFINITION:
 1 RTD 

MESSAGE NO: S2-10 APPLIES TO: Selected Heater
 DEFAULT VALUE: 1 RTD VALUE RANGE: See list below
 DISPLAY MODE: Advanced RESTRICTIONS: Heater Setpoint must not be
 off.

This function sets how the Heater Control Temperature is derived from dual RTD inputs as follows.

<u>Value</u>	<u>Heater Control Temperature</u>
1 RTD	RTD-A
RTD B HT cutoff	RTD-A but less than RTD-B
2 RTDs, lowest	Minimum of RTD-A & RTD-B
2 RTDs, highest	Maximum of RTD-A & RTD-B
2 RTDs, averaged	Average of RTD-A & RTD-B
2 RTDs, backup	RTD-A if okay, else RTD-B

When RTD B HT cutoff is selected, RTD-B temperature is compared with the high temperature alarm. When RTD-B temperature is equal to or greater than the high temperature alarm setting, the heater is turned off even if RTD-A temperature is less than the heater setpoint. Functions requiring two RTDs will operate in one RTD mode if one of the two RTDs fail.

IF RTD FAILS
 HEATER GOES: off 

MESSAGE NO: S2-11 APPLIES TO: Selected Heater
 DEFAULT VALUE: off VALUE RANGE: on, off
 DISPLAY MODE: Advanced RESTRICTIONS: Heater Setpoint must not be
 off.

This function sets the heater fail-safe state. The Control Module detects if the temperature sensor has failed. In this case, it will use only the second RTD input, if available, or it will set the heater to its fail-safe state. For freeze protection where there is no hazard from over heating, set to **on** to prevent freeze up. If there is a potential hazard from over heating, this setting should be set to **off**.

HEAT TRACE CURVE
 SETUP: disable 

MESSAGE NO: S2-12 APPLIES TO: Selected Heater
 DEFAULT VALUE: disable VALUE RANGE: LT3,LT5,LT8,LT10,HLT3
 HLT5,HLT8,HLT10,HLT12
 HLT15,HLT18,HLT20,
 3BTV,5BTV, 8BTV,10BTV,
 10QTVR,15QTVR,
 20QTVR,5XTV,10XTV,
 15XTV,20XTV,user,disable
 DISPLAY MODE: Advanced RESTRICTIONS: None

This function allows you to define the Watt/ft versus ambient temperature curve for the self-regulating heat trace cable being used. This curve is a single segment straight line approximation of the heat trace Watt/ft versus ambient temperature curve. With self-regulating cable low and high current alarms are difficult to monitor since heater current varies with temperature. If the controller can predict the heater current of the cable at different temperatures, the controller can offset the high and low current alarm settings to eliminate nuisance alarms. The MS-2101 uses the heater setpoint as a reference point on the curve such that the low and high current alarm values are based on expected heater current at the heater setpoint temperature. This eliminates the need for the total cable length. The controller calculates the expected Watt/ft at the control temperature and converts it to Amps/ft by dividing by the heater voltage. This value is subtracted from the Amps/ft at the heater setpoint temperature to obtain an offset value. The controller applies this offset the high and low current alarms. You may choose a preset heat

trace curve for a cable type listed or enter a custom curve. If set to **disable**, the controller will not apply an offset to the current alarms. When **user** is selected, two points are required for the controller to determine the user heat trace curve.

System Setup

SETPOINTS:
SYSTEM SETUP

MESSAGE NO: S3-01 APPLIES TO: Interface Module
 DEFAULT VALUE: N/A VALUE RANGE: N/A
 DISPLAY MODE: All RESTRICTIONS: None
 This message displays the name of the sub-menu when entered.

PROGRAM ACCESS:
enable

MESSAGE NO: S3-02 APPLIES TO: Interface Module
 DEFAULT VALUE: enable VALUE RANGE: enable, disable
 DISPLAY MODE: Advance RESTRICTIONS: None
 When set to **disable**, programming of setpoints is disabled to prevent unauthorized programming changes. Program Access works together with the Program Enable dip switch in an “OR” type logic. When both Program Access and the Program Enable dip switch are set to **disable**, setpoint programming is disallowed. When either Program Access or the Program Enable dip switch is set to **enable**, setpoint programming is permitted. When setting Program Access to **enable**, you will be prompted for a four digit security password, if a password is setup. The controller default is setup with no password. No password is required to disable Program Access. For security purposes, the Program Enable dip switch should be left in the disable position.

CHANGE PASSWORD?
no

MESSAGE NO: S3-03 APPLIES TO: Interface Module
 DEFAULT VALUE: no password VALUE RANGE: Any keys except for [STORE], up to 4 key combinations

yes [STORE]

DISPLAY MODE: Advanced RESTRICTIONS: None

ENTER OLD
PASSWORD: _ _ _ _

This function allows you to change the password required to enable Program Access. You must enter the old password for security purposes. The controller is shipped from the factory with no password and you can press [STORE] when prompted for the old password. You will be prompted to enter a new password and re-enter the new password for verification. Note that message up/down arrow keys cannot be used as the first digit of the password and [STORE] cannot be used in the password.

**** [STORE]

INVALID
PASSCODE

↓

CHANGE PASSWORD?
no

COST PER kWh:
\$0.05

MESSAGE NO: S3-04 APPLIES TO: Selected Control Module
 DEFAULT VALUE: \$0.05 VALUE RANGE: \$0.01 to \$0.50
 DISPLAY MODE: Advanced RESTRICTIONS: None
 This function sets the COST PER kWh. The controller uses this value to calculate Energy Cost.

ALARM CONTACTS:
MECH:NO  SS:N/A 

MESSAGE NO: S3-05 APPLIES TO: Interface Module
DEFAULT VALUE: MECH:NC VALUERANGE: MECH:NO SS:N/A
SS:N/A MECH:NO SS:N/A
MECH:NC SS:N/A
MECH:NC SS:N/A

DISPLAY MODE: Advanced RESTRICTIONS: None

This function configures the alarm contacts for normally open (NO) or normally closed (NC). MECH refers to the mechanical alarm contact on terminals 20 and 21 of the Control Module. SS refers to the solid-state alarm contact that is not available on board. In **NO** mode, the contact closes during alarm condition. In **NC** mode, the contact opens during alarm condition.

ALARM LATCHING:
low temp  yes 

MESSAGE NO: S3-06 APPLIES TO: Interface Module
DEFAULT VALUE: no VALUERANGE: low temp, high temp
low current, high current
gf alarm, RTDA failure
RTDB failure, switch fail
low voltage, high voltage
continuity
yes, no for each alarm

DISPLAY MODE: Advanced RESTRICTIONS: None

This function configures each alarm as latching or non-latching. Pressing [STORE] toggles the cursor between alarm selection and yes or no selection. Alarms selected as **yes** will be latched. Latching alarms will remain on the display eventhough the alarm condition no longer exist. To clear the alarm, you must press [STATUS] to display the alarm and press [RESET]. When the actual and alarm setpoint values are displayed, the actual value is the pre-alarm actual value. Tracecheck, ground fault trip and test alarms are latched only and not user definable.

ALARM LIGHT MODE:
alarm: off 

MESSAGE NO: S3-07 APPLIES TO: Interface Module
DEFAULT VALUE: alarm:off VALUERANGE: alarm:off, alarm:on
flash/on, flash/off

DISPLAY MODE: Advanced RESTRICTIONS: None

This function determines the response of the alarm light output to an alarm. The alarm light output is design to drive a 5Vdc LED. If the value is set to **alarm off**, the alarm light is **on** in a no alarm condition and turns **off** when alarms are present. The **alarm off** setting works best with a green LED for fail-safe mode where loss of power or a burnt out LED generates an alarm condition. Value **alarm on**, turns the alarm light **off** in a no alarm condition and turns **on** when alarms are present. Value **alarm flash/on** flashes the alarm light when alarms are present and turns **on** the alarm light when there are no alarms. Value **alarm flash/off** flashes the alarm light when alarms are present and turns **off** the alarm light when there are no alarms.

TEMPERATURE UNITS:
Celcius 

MESSAGE NO: S3-08 APPLIES TO: Interface Module
DEFAULT VALUE: Celsius VALUERANGE: Celsius, Fahrenheit
DISPLAY MODE: Advanced RESTRICTIONS: Heater Setpoint must not be
off.

This function sets the units of measure for temperature. All temperatures are displayed in the selected units of either degrees Celsius (°C) or degrees Fahrenheit (°F).

DISPLAY MODE:
advanced user 

MESSAGE NO: S3-09 APPLIES TO: Interface Module
 DEFAULT VALUE: advanced user VALUE RANGE: advanced user, normal user
 DISPLAY MODE: All RESTRICTIONS: None
 This function determines what messages are displayed. If set to **advanced user**, all messages are displayed. If set to **normal user**, only the basic messages are displayed. Each message listed in this chapter shows the Display Mode required to see the message. **Advanced** indicates that you must set the display mode to **advanced user** to view the message.

DEFAULT DISPLAY:
System Status 

MESSAGE NO: S3-10 APPLIES TO: Interface Module
 DEFAULT VALUE: System status VALUE RANGE: See values below
 DISPLAY MODE: Advanced RESTRICTIONS: Heater Temp messages are not displayed if Heater setpoint is **off**.

This function specifies the information that will be displayed when no key has been pressed for the Display Timeout interval as described below.

VALUE	INFORMATION DISPLAYED
System status	Alarm status
Heater status	Heater on or off
Heater temp	Control temperature

DISPLAY TIMEOUT:
60 seconds 

MESSAGE NO: S3-11 APPLIES TO: Interface Module
 DEFAULT VALUE: 60 s VALUE RANGE: 5 to 600 s, off
 DISPLAY MODE: Advanced RESTRICTIONS: None
 This function sets the length of time, from the last key press, to automatically return to the Default Display information. To disable this function, set the value to **off**.

SCAN TIME:
2 seconds 

MESSAGE NO: S3-12 APPLIES TO: Interface Module
 DEFAULT VALUE: 3 s VALUE RANGE: 1 to 10 s
 DISPLAY MODE: Advanced RESTRICTIONS: None
 This function sets the length of time between the display of successive messages. Select a value that is comfortable for the viewing speed of the operator.

SETMODULE
NUMBER: 1 

MESSAGE NO: S3-13 APPLIES TO: Control Module
 DEFAULT VALUE: 1 VALUE RANGE: 1-250
 DISPLAY MODE: Advanced RESTRICTIONS: None
 This function changes the Module Number of the Control Module. If a controller is to communicate along with other modules to a central computer or display, each module must have a unique address to ensure only one module attempts to communicate with the remote display at any time. The address for communication is the module number.

RESET CONTROL
MODULE? no ↗

yes [STORE]

ARE YOU SURE?
no ↗

yes [STORE]

MODULE
RESET

BAUD RATE:
1200 ↗

MESSAGE NO: S3-14 APPLIES TO: Control Module
DEFAULT VALUE: no VALUE RANGE: yes, no
DISPLAY MODE: Advanced RESTRICTIONS: None

This function resets all values of the Control Module to the default values. Select **yes** to proceed. Select **yes** again to confirm.

This message confirms that the Control Module was reset.

MESSAGE NO: S3-15 APPLIES TO: Interface Module
DEFAULT VALUE: 1200 VALUE RANGE: 600,1200,2400,4800,9600
DISPLAY MODE: Advanced RESTRICTIONS: None

This function sets the communication baud rate for the RS-485 serial port. All controllers connected to the same data highway must operate at the same baud rate.

Setpoint Tests

SETPOINTS
TEST

MESSAGE NO: S4-01 APPLIES TO: Interface Module
DEFAULT VALUE: N/A VALUE RANGE: N/A
DISPLAY MODE: Advanced RESTRICTIONS: None

This message displays the name of the sub-menu when entered.

ALARM TEST:
disabled ↗

MESSAGE NO: S4-02 APPLIES TO: Selected Control Module
DEFAULT VALUE: disabled VALUE RANGE: 1 to 24 hrs, disabled,
on continuously

DISPLAY MODE: Advanced RESTRICTIONS: None

This function manually controls of the alarm output for maintenance purposes. For normal operation, set to **disable**. If you select a period of time, the alarm output is forced into alarm state for the selected interval. If you select **on continuously**, the alarm output is forced into alarm state until you select **disabled**. Alarm state is determined by ALARM CONFIG function setting.

HEATER TEST:
disabled ↗

MESSAGE NO: S4-03 APPLIES TO: Selected Heater
DEFAULT VALUE: disabled VALUE RANGE: 1 to 24 hrs, disabled,
on continuously

DISPLAY MODE: Advanced RESTRICTIONS: None

This function manually overrides heater control for maintenance purposes. For normal operation, set to **disable**. If you select a period of time, the heater is forced **on** for the selected interval. If you select **on continuously**, the heater is forced on until you select **disabled**.



MESSAGE NO: S4-04 APPLIES TO: Selected Control Module
DEFAULT VALUE: disabled VALUE RANGE: 1 to 24 hrs, test now,
disabled

DISPLAY MODE: Advanced RESTRICTIONS: None

This function tests the ground fault monitoring function of the controller to ensure proper operation. When the ground fault test is turned **on**, the controller applies an ac current to the ground fault transformer and checks the measured ground fault current. If the controller does not see the test current, the GF Test Alarm is activated and a **GF CT** message is added to the system status messages. This is a latching alarm. When the cause of the alarm has been corrected, locate the alarm message in the Status Menu and press [RESET]. If there is no problem detected, no alarm message is displayed.

Overview

The MS-2101 is capable of generating many different types of alarms. In this chapter, alarms are organized in three groups: trip or failure, heater and warning. Each group represents a level of severity with the trip or failure type being extremely critical, the process type requiring some attention and warning type indicating those that do

not require immediate attention. Each group is detailed by section throughout this chapter.

Access alarms by pressing [STATUS] where the total number of alarms is displayed. You must review each alarm by pressing [MESSAGE ↕] several times, each time displaying information about each alarm including the alarm name and reason for the alarm.

Trip or Failure Alarms

GROUND FAULT
ALARM

The measured ground fault current is greater than or equal to the Ground Fault Alarm setpoint or, the ground fault current is greater than the maximum value range.

- ✓ Check that the setpoint is appropriate for the length and type of cable.
- ✓ Check for wet or damaged heating cable, power connections, splices or tees.
- ✓ Test for correct ground fault measurement.

CONTINUITY CHECK
FAIL

The controller is calling for heat and the actual current is zero.

- ✓ Check field wiring for poor connections.
- ✓ For serial type heaters such as mineral insulated cable, check for breakage.

GROUND FAULT
TRIP

The measured ground fault current is greater than or equal to the Ground Fault Trip setpoint.

- ✓ Check that the setpoint is appropriate for the length and type of cable.
- ✓ Check for wet or damaged heating cable, power connections, splices or tees.
- ✓ Test for correct ground fault measurement.

SELF TEST
FAILURE ALARM

A memory or CPU failure has occurred.

- ✓ The Control Module needs repair.

GF TEST
FAIL

Ground fault monitoring function did not detect the GF test current.

- ✓ Ground fault current transformer may be faulty.
- ✓ Ground fault monitoring function may be faulty and controller needs repair.

SWITCH FAIL
SHORTED

The heater current is greater than or equal to 0.1 A when the heater circuit is off.

- ✓ Check SCRs for failure in short circuit state.
- ✓ Controller may be faulty and needs repair.

RTD FAIL
OPEN

The temperature derived from the RTD resistance has exceeded 500 °C.

- ✓ Check for damaged RTD, cable or open connection.
- ✓ Pipe temperature has exceeded 500°C.
- ✓ Test the RTD input.

<p>RTD FAIL FAULT</p>

An RTD problem has been detected.

- ✓ Check for damaged RTD, cable or connection for short circuit.
- ✓ Check middle lead of RTD (terminal 7 or 11) for open connection.
- ✓ Pipe temperature has dropped below -50°C.
- ✓ Test the RTD input.

Process Alarms

<p>HIGH TEMPERATURE ALARM</p>

The Heater Control Temperature is greater than or equal to the High Temperature Alarm setpoint. For dual RTD Control Modules, the RTD Mode determines how the Heater Control Temperature is derived.

- ✓ Check that the alarm setpoint is correct.
- ✓ Test for correct RTD operation.
- ✓ Check the heat trace design.

<p>LOW TEMPERATURE ALARM</p>

The Heater Control Temperature is less than or equal to the Low Temperature Alarm setpoint. The RTD Mode determines how the Heater Control Temperature is derived.

- ✓ Check that the alarm setpoint is correct.
- ✓ Test for correct RTD operation.
- ✓ Check for damaged insulation or cladding.
- ✓ Check for damaged heat trace.
- ✓ Check the heat trace design.

<p>HIGH CURRENT ALARM</p>

The measured Heater Current, when the heater circuit is **on**, is greater than or equal to the High Current Alarm setpoint or, the Heater Current is greater than the maximum value range.

- ✓ Check that the alarm setpoint is correct.
- ✓ For self-regulating heating cable, the current varies substantially with temperature. Check that the alarm setpoint accounts for this variation or use the heat trace curve function.
- ✓ Test for correct current measurement.

<p>LOW CURRENT ALARM</p>

The measured Heater Current, when the heater circuit is **on**, is less than or equal to the Low Current Alarm setpoint.

- ✓ Check that the alarm setpoint is correct.
- ✓ For self-regulating heating cable, the current varies substantially with temperature. Check that the alarm setpoint accounts for this variation or use the heat trace curve function.
- ✓ Test for correct current measurement.
- ✓ For parallel resistance heating cable, check for broken cable, failed splice or tee connection.
- ✓ For zone-type heating cable, check for failed zones.

<p>HIGH VOLTAGE ALARM</p>

The measured circuit voltage is greater than or equal to the High Voltage Alarm setpoint.

- ✓ Check for voltage input failure by measuring the voltage at the Heater Voltage terminals.
- ✓ If a control transformer is used for input power, check wiring configuration to the transformer.

LOW VOLTAGE
ALARM

The measured circuit voltage is less than or equal to the Low Voltage Alarm setpoint.

- ✓ Check for voltage input failure by measuring the voltage at the Heater Voltage terminals.
- ✓ If a control transformer is used for input power, check wiring configuration to the transformer.
- ✓ Check loading on power system. Possible brown out.

Warning Alarms

ALARM DURING
TRACECHECK

One of the following alarms occurred during the TraceCheck™ cycle. Refer to the alarm details above for the individual alarm.

- ✓ TC SWITCH SHORTED ALARM
- ✓ TC LOSS OF CONTINUITY
- ✓ TC HIGH CURRENT ALARM
- ✓ TC LOW CURRENT ALARM
- ✓ TC GROUND FAULT ALARM
- ✓ TC GROUND FAULT TRIP

Reset Alarms

Some alarms such as TraceCheck type, Ground Fault Trip and Ground Fault test are latching. The alarm remains on the display even after the alarm condition has gone away. Latch alarms require you to acknowledge or reset the

alarm.

To reset alarms,

1. Press [STATUS].
2. Press [MESSAGE ↵] to locate the alarm message.
3. Press [RESET].

The alarm should be cleared from the display unless the alarm condition is still present.

Overview

The MS-2101 heat trace controller communicates with computerized equipment such as programmable logic controllers, desktop computers or man-machine interfaces using Modicon Modbus protocol. The MS-2101 supports a subset of the Remote Terminal Unit (RTU) format of the protocol that provides extensive monitoring, programming and control functions using read and write register commands. The MS-2101 always acts as a slave device such that it does not initiate communications; it only listens and responds to requests issued by a master computer.

Physical Layer

Modbus protocol is hardware independent so that the physical layer can be a variety of hardware mediums such as RS-485, RS-422, RS-232 or fiber optics. The MS-2101 is configured with one RS-485 port. Refer to *Chapter 2 Installation*, for wiring details.

Each data bit is transmitted in an asynchronous format consisting of 1 start bit and 1 stop bit to produce a 10-bit data frame. This is important for transmission through modems at higher bit rates (11 bit frames are not supported by some modems at bit rates greater than 300bps). The baud rate on the serial port is programmable. Baud rates of 1200, 2400, 4800 and 9600 are available. Parity is fixed to *none*. Refer to *Chapter 6 Setpoint Values*, for details on baud rate configuration.

The master device must know the address (module number) of the slave device in order to communicate with it. The MS-2101 does not respond to requests from the master unless the request matches the controller's module number. Refer to *Chapter 6 Setpoint Values*, for details on setting the module number.

Modbus Protocol

This section discusses the Modbus protocol.

Data Structure: Data communications take place in packets, which consist of multiple asynchronously framed data. The master sends a packet to the slave and the slave responds with a packet. End of packet is determined by a **dead time** on the data highway.

Modbus packet Format:

Slave Address:	1 byte
Function Code:	1 byte
Data:	<i>N</i> bytes
CRC:	2 bytes
Dead Time:	3.5 bytes transmission time

Slave Address: This is referred to as module number on the MS-2101 that is to receive packets sent by the master and respond to the request. The module number must be unique for each controller on the data highway to avoid

bus contention. The module number is user defineable from 1 to 250; refer to *Chapter 6 Setpoint Values* for details. Only the addressed slave responds to a packet that starts with its module number.

Function Code: The function code tells the slave what action to perform. Refer to supported functions in this section for details.

Data: The number of bytes depends on the function code. Data include setpoints, Measured Values, or alarm status or addresses sent between the master and slave.

CRC: Short for Cyclic Redundancy Check, CRC is an industry standard method used for error detection. Modbus RTU includes a 16-bit CRC with every packet. When a slave receives a packet that is in error due to CRC the slave device ignores the packet to prevent any erroneous operation.

Dead Time: End of transmission of a packet is determined when no data is received for a period of 3.5 byte transmission times (about 15ms at 2400 baud and 4ms at 9600 baud). Consequently, the transmitting device must not allow gaps between bytes longer than this interval. Once the dead time has expired without a new byte transmission, all slaves start listening for a new packet from the master except the addressed slave.

Supported Function Codes: The following functions are supported by MS-2101 firmware:

CODE	Address Range	Type	Interpretation
03	40001-50000	Holding Register	Read variable registers
05	1-10000	Output Coil	Reset heater alarm or statistics
06	40001-50000	Holding Register	Store value into one variable register
16	40001-50000	Holding Register	Store value into a group of variable registers

Note: Any slave module must have a unique address within 1 - 250. Address 255 is reserved for module commissioning & addressing.

Function code 03 - Read Variable Registers

Modbus implementation: Read Holding Registers
 MS-2101 implementation: Read variable registers
 In Modbus, Read Holding Registers is used to obtain current binary value in one or more holding registers. It assumes that each register is a 16-bit register. For the MS-2101 implementation of Modbus, this function obtains value from one variable register or values from a group of variable registers.

This command can access only the variable registers with Memory Location Index between 0 (the first index in Module Setup Group) and 164 (the last index in Heater Statistics Group). Any attempts to read a variable register with Memory Location Index beyond the above range results in an error response in return.

Master Query: It consists of module address, function code, memory location index of the starting variable register, number of variable registers to be read and CRC error check.

Slave Response: It consists of module address, function code, quantity of data bytes to be returned, data value and CRC error check.

Message Format and Example:

Request slave 11 to respond with local heater #1's low current alarm level. Suppose heater #1's low temperature alarm level is 10.1 °C. Here are transmission and response messages:

Master Transmission	Bytes	Message Contents (Decimal)
Slave Address	1	11 (message to slave 11)
Function Code	1	3 (command "read variable registers")
Memory Location Index	2	73 (refer to register storing local heater #1's low temp level)
Number of Registers	2	1 (a 2-byte variable)
CRC	2	????

Slave Response	Bytes	Message Contents (Decimal)
Slave Address	1	11 (message from slave 11)
Function Code	1	3 (command "read variable registers")
Quantity of Data Bytes	1	2 (2 bytes)
Data Value	2	101 (10.1 °C)
CRC	2	????

Function code 05 - Reset Heater Alarms & Statistics

Modbus implementation: Force Single Coil

MS-2101 implementation: Reset heater alarms & statistics

In Modbus, Force Single Coil forces logic coil to a state of ON or OFF.

For the MS-2101 implementation of Modbus, this function resets the heater alarm or statistics. Once an MS-2101 control module is in use, it keeps monitoring heater alarms and updating heater statistics. Some of the alarms are latched even after the alarm condition no longer exists. It's up to the user to reset those latched alarms and some statistics. By sending a data value 65280 (FF00 Hex) to any variable register with Memory Location Index between 165 and 186 (Heater Alarm Reset & Statistics Reset Group), the corresponding alarm or statistics will be reset. Sending a data value 0 to any register within the above range is legal but will have no effect. Sending a data value other than 65280 and 0 to any register within the range or sending any data to any register beyond the range is illegal and will result in an

error response in return.

Master Query: It consists of module address, function code, memory location index of the variable register, data value FF00 Hex and CRC error check.

Slave Response: It consists of module address, function code, memory location index of the variable register, data value FF00 Hex and CRC error check.

Message Format and Example:

Request slave 200 to reset local heater #10's minimum temperature. Here are transmission and response messages:

Master Transmission	Bytes	Message Contents (Decimal)
Slave Address	1	200 (message to slave 200)
Function Code	1	5 (command "reset heater alarm and statistics")
Memory Location Index	2	173 + (10-1) * 190
Data Value	2	65280 (FF00 Hex)
CRC	2	????

Slave Response	Bytes	Message Contents (Decimal)
Slave Address	1	200 (message from slave 200)
Function Code	1	5 (command "reset heater alarm and statistics")
Memory Location Index	2	173 + (10-1) * 190
Data Value	2	65280 (FF00 Hex)
CRC	2	????

Function code 06 - Store a Value into one Variable Register

Modbus implementation: Preset Single Register

MS-2101 implementation: Store a value into one variable register

In Modbus, Preset Single Register places a specific binary value into a holding register. For the MS-2101 implementation of Modbus, this function is used to store a value into one variable register with Memory Location Index in Module Setup Group (0 to 30), Module Setting Group (31 to 43) and Heater Setpoints Group (71 to 108). Any attempts to store a value into a variable register beyond the above range results in an error response.

Master Query: It consists of module address, function code, memory location index of the variable register, data value and CRC error check.

Slave Response: It consists of module address, function code, memory location index of the variable register, data value and CRC error check.

Message Format and Example:

Request slave 98 to change its local heater #10's heater setpoint to 30 °C. Here are transmission and response messages:

Master Transmission	Bytes	Message Contents (Decimal)
Slave Address	1	98 (message to slave 98)
Function Code	1	6 (command "store a value into one variable register")
Memory Location Index	2	72 + (10-1) * 190
Data Value	2	300 (30.0°C)
CRC	2	????

Slave Response	Bytes	Message Contents (Decimal)
Slave Address	1	98 (message from slave 98)
Function Code	1	6 (command "store a value into one variable register")
Memory Location Index	2	72 + (10-1) * 190
Data Value	2	300 (30.0°C)
CRC	2	????

Function code 16 - Store Values into a Group of Variable Registers

Modbus implementation: Reset Multiple Registers
 MS-2101 implementation: Store values into a group Variable registers

In Modbus, Preset Multiple Registers places specific binary values into a series of consecutive holding registers. It assumes that each register is 16-bit register. For the MS-2101 implementation of Modbus, it is the same thing. Using this command, a group of consecutive variable registers can be assigned to their desired values. This command can access only the variable registers with Memory Location Index in Module Setting Group (31 to 43) and Heater Setpoints Group (71 to 108). Any attempts to store values into variable registers with Memory Location Index beyond the above range results in an error response in return.

Master Query: It consists of module address, function code, memory location index of the starting variable register, number of variable registers to be stored, quantity of data bytes to be stored, data value and CRC error check.

Slave Response: It consists of module address, function code, memory location index of the starting variable register, quantity of data bytes stored and CRC error check.

Message Format and Example:

Request slave 11 to set local heater #1's low temperature alarm level to 5 °C and high temperature alarm level to 300 °C. Here are transmission and response messages:

Master Transmission	Bytes	Message Contents (Decimal)
Slave Address	1	11 (message to slave 11)
Function Code	1	16 (command "store value to a group of variable registers")
Memory Location Index	2	73
Number of Registers	2	2 (2 variable registers)
Quantity of Data Bytes	1	4 (4 bytes)
Data Value	4	50 (50°C for low temp alm level) 3000 (300°C for high temp alm level)
CRC	2	????

Slave Response	Bytes	Message Contents (Decimal)
Slave Address	1	11 (message from slave 11)
Function Code	1	16 (command "store value to a group of variable registers")
Memory Location Index	2	73
Number of Registers	2	2 (2 variable registers)
CRC	2	????

Module Commissioning & Addressing

A MS-2101 module contains a whole set of setpoints and module settings. It also has its assigned module address. Any customer equipment (Master) with Modbus communication protocol can reset all heater setpoints and module settings to their default values, read a module's assigned address or assign a new address to a module. It is called Module Commissioning & Addressing. To avoid any careless errors, only the module that is in listening to new address mode (The ADDRESS ENABLE dip switch is set to the enable position) responds to Module Commissioning & Addressing commands.

To perform module commissioning on an MS-2101 module, a Master must use Function 06 to store a value of 0 into the variable register with Memory Location Index 187. To read a module's address, a Master must use Function 03 to read the value stored in the variable register with Memory Location Index 188.

To assign a new address to a module's address, a Master must use Function 06 to store a desired address into the variable register with Memory Location Index 189.

Note: The slave address of the above module commissioning & addressing commands is fixed to 255.

Message Format and Example:

Assign a module to a new address 230. Here are transmission and response messages:

Master Transmission	Bytes	Message Contents (Decimal)
Slave Address	1	255 (always 255)
Function Code	1	6 (command "store a value into one variable register")
Memory Location Index	2	189 (refer to the register for assigning address)
Data Value	2	230 (new address)
CRC	2	????

Slave Response	Bytes	Message Contents (Decimal)
Slave Address	1	255 (always 255)
Function Code	1	6 (command "store a value into one variable register")
Memory Location Index	2	189 (refer to the register for assigning address)
Data Value	2	230 (new address)
CRC	2	????

MS-2101 Error Responses

If a MS-2101 module receives a transmission in which an error is indicated by framing, format, overrun or the CRC calculation, the module will not respond to the transmission.

When a MS-2101 module detects an error other than a framing, format, overrun or CRC error, a response will be sent to the master. The most significant bit of the FUNCTION CODE byte will be set to 1 (that is the function code sent from the slave will be equal to the function code sent from the master plus 128). The byte that follows it will be an exception code indicating the type of error that occurred.

The slave response to an error (other than CRC error) will be:

Slave Response	Bytes	Message Contents (Decimal)
Slave Address	1	????
Function Code	1	????
Exception Code	1	????
CRC	2	????

The MS-2101 implements the following exception response codes.

01 - ILLEGAL FUNCTION

The function code transmitted by the master is not one of the functions supported by MS-2101.

02 - ILLEGAL MEMORY LOCATION INDEX

The index transmitted by the master is not allowable.

08 - ILLEGAL ADDRESS ENABLE DIP SWITCH POSITION

The address enable dip switch on MS-2101 controller is in the wrong position

Modbus Memory Map

Module Setup Group:

Modbus Register	Index Value	Length Bytes	Variable Name
40001	0	2	Reserved for manufacturer use
40002	1	2	Reserved for manufacturer use
40003	2	2	Reserved for manufacturer use
40004	3	2	Reserved for manufacturer use
40005	4	2	Reserved for manufacturer use
40006	5	2	Reserved for manufacturer use
40007	6	2	Reserved for manufacturer use
40008	7	18	Module Firmware Version ²
40017	16	4	Reserved for manufacturer use
40019	18	4	Reserved for manufacturer use
40021	20	4	Reserved for manufacturer use
40023	22	4	Reserved for manufacturer use
40025	24	4	Reserved for manufacturer use
40027	26	2	Reserved for manufacturer use
40028	27	2	Module Communication Baud Rate For Serial Port #1
40029	28	2	Reserved for manufacturer use
40030	29	2	Module Alarm Light Mode
40031	30	2	Module Alarm Contact
40032	31	2	Module RTD Selection
40033	32	2	Module Energy Cost Per kWh
40034	33	2	Reserved for manufacturer use
40035	34	2	Product Code ^{1,2}

- 1. For manufacturer use only
- 2. Read only

Modbus Register	Index Value	Length Bytes	Variable Name
40036	35	2	Reserved for manufacturer use
40037	36	2	Reserved for manufacturer use
40038	37	2	Module Manual Alarm
40039	38	2	Module GF Test
40040	39	2	Heat Trace Curve (Options)
40041	40	4	Heat Trace Curve Slope of User Defined Curve
40043	42	4	Heat Trace Curve Offset of User Defined Curve

Module Status and Statistics Group:

(Read only)

Modbus Register	Index Value	Length Bytes	Variable Name
40045	44	4	Module Status
40047	46	4	Module Total Running Hours (32-bit floating point data) ²
40049	48	4	Module Total Running Hours (32-bit unsigned integer) ⁵
40051	50	4	Module Total Energy Used (32-bit floating point data)
40053	52	4	Module Total Energy Used (32-bit unsigned integer)
40055	54	4	Module Total Energy Cost (32-bit floating point data)
40057	56	4	Module Total Energy Cost (32-bit unsigned integer)
40059	58	4	Module Total Running Days (32-bit floating point data)
40061	60	4	Module Total Running Days (2-bit unsigned integer)
40063	62	4	Module Total Running Days Since Reset (32-bit floating point data)
40065	64	4	Module Total Running Days Since Reset (2-bit unsigned integer)

Heater Setpoints Group:

Modbus Register	Index Value	Length Bytes	Variable Name
40067	66	4	Reserved for manufacturer use
40069	68	4	Reserved for manufacturer use
40071	70	2	Reserved for future expansion
40072	71	2	Heater Enabled
40073	72	2	Heater Setpoint
40074	73	2	Low Temperature Alarm Setting
40075	74	2	High Temperature Alarm Setting
40076	75	2	Low Current Alarm Setting
40077	76	2	Reserved for manufacturer use
40078	77	2	Reserved for manufacturer use
40079	78	2	High Current Alarm Setting
40080	79	2	Reserved for manufacturer use
40081	80	2	Reserved for manufacturer use
40082	81	2	Reserved for manufacturer use
40083	82	2	Reserved for manufacturer use
40084	83	2	Reserved for manufacturer use
40085	84	2	Ground Fault Trip Setting
40086	85	2	Ground Fault Alarm Setting
40087	86	2	Powerlimit Current Setting

Modbus Register	Index Value	Length Bytes	Variable Name
40088	87	2	TraceCheck Setting
40089	88	2	Heater Set Voltage
40090	89	2	Low Voltage Alarm Setting
40091	90	2	Proportional Control
40092	91	2	Failure RTD Action
40093	92	2	Manual Heater
40094	93	18	Heater Name
40103	102	2	Override
40104	103	2	Deadband Setting
40105	104	2	Softstart
40106	105	2	High Voltage Alarm Setting
40107	106	2	Reserved for manufacturer use
	107-108		Reserved for future expansion

Heater Status and Measured Values Group:
(Read only)

Modbus Register	Index Value	Length Bytes	Variable Name
40110	109	4	Heater Status
40112	111	6	Heater Alarm Status
40115	114	2	Heater Control Temperature
40116	115	2	RTD A Actual Temperature
40117	116	2	RTD B Actual Temperature
40118	117	2	Heater On Percentage
40119	118	2	Heater Current
40120	119	2	Reserved for manufacturer use
40121	120	2	Reserved for manufacturer use
40122	121	2	Ground Fault Current
40123	122	2	Heater Voltage
40124	123	2	Pre-trip Ground Fault Current
40125	124	2	Reserved for manufacturer use
40126	125	2	Reserved for manufacturer use
40127	126	2	Reserved for manufacturer use
	127-130		Reserved for future expansion

Heater Statistics Group:
(Read only)

Modbus Register	Index Value	Length Bytes	Variable Name
40132	131	2	Maximum Temperature
40133	132	2	Minimum Temperature
40134	133	2	Maximum Heater Current
40135	134	2	Reserved for manufacturer use

1. For manufacturer use only
2. Read only

Modbus Register	Index Value	Length Bytes	Variable Name
40136	135	2	Reserved for manufacturer use
40137	136	2	Maximum Ground Fault Current
40138	137	4	Energy Used Last Day (32-bit floating point data)
40140	139	4	Energy Used Last Day (32-bit unsigned integer)
40142	141	4	Energy Cost Last Day (32-bit floating point data)
40144	143	4	Energy Cost Last Day (32-bit unsigned integer)
40146	145	4	Energy Used (32-bit floating point data)
40148	147	4	Energy Used (32-bit unsigned integer)
40150	149	4	Energy Cost (32-bit floating point data)
40152	151	4	Energy Cost (32-bit unsigned integer)
40154	153	4	Heater Turn On Hours (32-bit floating point data)
40156	155	4	Heater Turn On Hours (32-bit unsigned integer)
40158	157	2	Heater Percentage of Turn On Time
40159	158	2	Heater Turn On Days (32-bit floating point data)
40161	160	2	Heater Turn On Days (32-bit unsigned integer)
40163	162	2	Maximum Voltage
40164	163	2	Minimum Voltage

Heater Alarm Reset and Statistics Reset Group:

Modbus Register	Index Value	Length Bytes	Variable Name
165	164	2	Reset TraceCheck Continuity Alarm
166	165	2	Reset Ground Fault Trip Alarm
167	166	2	Reset TraceCheck Ground Fault Alarm
168	167	2	Reset TraceCheck Low Current Alarm
169	168	2	Reset TraceCheck High Current Alarm
170	169	2	Reset TraceCheck Ground Fault Trip Alarm
171	170	2	Reset TraceCheck Switch Shorted Alarm
172	171	2	Reset Statistics
173	172	2	Reset Maximum Temperature
174	173	2	Reset Minimum Temperature
175	174	2	Reset Maximum Current
176	175	2	Reserved for manufacturer use
177	176	2	Reserved for manufacturer use
178	177	2	Reset Maximum Ground Fault Current
179	178	2	Reset Energy Used
180	179	2	Reset Energy Cost
181	180	2	Reset Turn On Hours
182	181	2	Reserved for manufacturer use

Modbus Register	Index Value	Length Bytes	Variable Name
183	182	2	Reserved for manufacturer use
184	183	2	Reserved for manufacturer use
185	184	2	Reset GF Test Alarm
186	185	2	Reset Maximum Voltage
187	186	2	Reset Minimum Voltage

Module Commissioning and Address Group:

Modbus Register	Index Value	Length Bytes	Variable Name
40188	187	2	Module Commission
40189	188	2	Test Module Address
40190	189	2	Assign Module Address

Modbus Map Data Format

Module Setup Group:

Modbus Register	Bytes	Variable Name	Value Range
40001	2	Reserved for manufacturer use	
40002	2	Reserved for manufacturer use	
40003	2	Reserved for manufacturer use	
40004	2	Reserved for manufacturer use	
40005	2	Reserved for manufacturer use	
40006	2	Reserved for manufacturer use	
40007	2	Reserved for manufacturer use	
40008	18	Reserved for manufacturer use	
40017	4	Reserved for manufacturer use	
40019	4	Reserved for manufacturer use	
40021	4	Reserved for manufacturer use	
40023	4	Reserved for manufacturer use	
40025	2	Reserved for manufacturer use	
40027	2	Reserved for manufacturer use	
40028	2	Module Communication Baud Rate For Serial Port #1	= 0 if baud rate is 600 = 1 if baud rate is 1200 = 2 if baud rate is 2400 = 3 if baud rate is 4800 = 4 if baud rate is 9600
40029	2	Reserved for manufacturer use	
40030	2	Alarm Light	=0 if On when there is an alarm =1 if Off when there is an alarm =2 if Flash when there is an alarm otherwise Off =3 if Flash when there is an alarm otherwise On
40031	2	Alarm Contact	=0 if mechanical = NO and solid-state = N/A =1 if mechanical = NO and solid-state = N/A =2 if mechanical = NC and solid-state = N/A =3 if mechanical = NC and solid-state = N/A

Module Setting Group:

Modbus Register	Bytes	Variable Name	Value Range
40032	2	Module RTD Selection	= 0 if RTD A is used, RTD B for backup = 1 if two RTDs average used = 2 if the higher reading of two RTDs is used = 3 if the lower reading of the two RTDs is used = 4 if RTD B is used for high temperature cutoff = 5 if only RTD A reading is used
40033	2	Module Energy Cost Per kWh	1-50 (in unit of cent)
40034	2	Reserved for manufacturer use	
40035	2	Product Code 1,2	= 5 if module is MS1 MKII type 3
40036	2	Reserved for manufacturer use	
40037	2	Reserved for manufacturer use	
40038	2	Module Manual Alarm	= 0 if alarm test is disabled = x if alarm test is on for x hours (1<=x<=24) = 25 if alarm test is on continuously

1. For manufacturer use only
2. Read only
3. Hardcode setting.

Modbus Register	Bytes	Variable Name	Value Range
40039	2	Module GF Test	= 0 if GF test is disabled = x if GF test is on for x hours (1<=x<=24) = 25 if GF test is to start when store key is pressed
40040	2	Heat Trace Curve	= 0 for Nelson LT3 Self-Regulating Cable = 1 for Nelson LT5 Self-Regulating Cable = 2 for Nelson LT8 Self-Regulating Cable = 3 for Nelson LT10 Self-Regulating Cable = 4 for Nelson HLT3 Self-Regulating Cable = 5 for Nelson HLT5 Self-Regulating Cable = 6 for Nelson HLT8 Self-Regulating Cable = 7 for Nelson HLT10 Self-Regulating Cable = 8 for Nelson HLT12 Self-Regulating Cable = 9 for Nelson HLT15 Self-Regulating Cable = 10 for Nelson HLT18 Self-Regulating Cable = 11 for Nelson HLT20 Self-Regulating Cable = 12 for Raychem 3BTX Self-Regulating Cable = 13 for Raychem 5BTX Self-Regulating Cable = 14 for Raychem 8BTX Self-Regulating Cable = 15 for Raychem 10BTX Self-Regulating Cable = 16 for Raychem 10QTVR Self-Regulating Cable = 17 for Raychem 15QTVR Self-Regulating Cable = 18 for Raychem 20QTVR Self-Regulating Cable = 19 for Raychem 5XTV Self-Regulating Cable = 20 for Raychem 10XTV Self-Regulating Cable = 21 for Raychem 15XTV Self-Regulating Cable = 22 for Raychem 20XTV Self-Regulating Cable = 23 User Defined = 24 Disable
40041	4	Heat Trace Curve Slope of User Defined Curve	32-bit Floating Point Format Watt/Ft-°F
40043	4	Heat Trace Curve Offset of User Defined Curve	32-bit Floating Point Format Watt/Ft

Module Status Group:

Modbus Register	Bytes	Variable Name	Values
40045	4	Module Status	<p>First Byte:</p> <p>b1-b0 : output switch type¹ 00 : solid-state³ 01 : relay</p> <p>b2 : number of phases¹ 0 : one phase³ 1 : three phase</p> <p>b4-b3 : RTD mode¹ 00 : no RTD 01 : one RTD 02 : two RTD³ 03 : one thermocouple</p> <p>b5 : maximum current¹ 0 : 30A³ 1 : 100A</p> <p>b6 : alarm present bit¹ 0 : no alarms 1 : alarms present</p> <p>b7 : maximum GF current¹ 0 : 3A 1 : 1A³</p> <p>Second Byte:</p> <p>b3-b0 : number of heaters¹ 0001 : MS1 or MS1 MKII³ 0010 : MS2 0101 : MS5 1010 : MS10</p> <p>b5-b4 : output switch type¹ 00 : solid-state³ 01 : relay 10 : user defined</p> <p>b6 : temperature measurement range¹ 0 : -50°C to +350°C 1 : -50°C to +500°C³</p> <p>b7 : Reserved for manufacturer use</p>

1. For manufacturer use only
2. Read only
3. Hardcode setting.
4. Not applicable to MS-2101

Module Statistics Group:

(Read only)

Modbus Register	Bytes	Variable Name
40047	4	Module Total Running Hours (32-bit floating point data, in Hours) ²
40049	4	Module Total Running Hours (32-bit unsigned integer, in 1/10 Hours) ²
40051	4	Module Total Energy Used (32-bit floating point data, in KWh)
40053	4	Module Total Energy Used (32-bit unsigned integer, in KWh)
40055	4	Module Total Energy Cost (32-bit floating point data, in Cents)
40057	4	Module Total Energy Cost (32-bit unsigned integer, in Cents)
40059	4	Module Total Running Days (32-bit floating point data, in Days) ²
40061	4	Module Total Running Days (32-bit unsigned integer, in Days) ²
40063	4	Module Total Running Days Since Reset (32-bit floating point data, in Days)
40065	4	Module Total Running Days Since Reset (32-bit unsigned integer, in Days)

Heater Setpoint Group:

Modbus Register	Length Bytes	Variable Name	Value Range
40067	4	Reserved for manufacturer use	
40069	4	Reserved for manufacturer use	
40071	2	Reserved for future expansion	
40072	2	Heater Enabled	= 0 if heater is disabled = 1 if heater is enabled
40073	2	Heater Setpoint	= x if set to x/10 °C (0<= x <=5000) = 5010 if set to off = 5020 if set to none
40074	2	Low Temperature Alarm Setting	= x if set to x/10 °C (0<= x <=5000) = 5010 if set to off
40075	2	High Temperature Alarm Setting	= x if set to x/100 A (0<= x <=5000) = 5010 if set to off
40076	2	Low Current Alarm Setting	For 30A Rating = x if set to x/100 A (0<= x <=3000) = 10050 if set to off
40077	2	Reserved for manufacturer use	
40078	2	Reserved for manufacturer use	
40079	2	High Current Alarm Setting	For 30A Rating = x if set to x/100 A (0<= x <=3000) = 10050 if set to off
40080	2	Reserved for manufacturer use	
40081	2	Reserved for manufacturer use	
40082	2	Reserved for manufacturer use	
40083	2	Reserved for manufacturer use	
40084	2	Reserved for manufacturer use	
40085	2	Ground Fault Trip Alarm Setting	= x if set to x mA (10<= x <=1000) = 1005 if set to off
40086	2	Ground Fault Alarm Setting	= x if set to x mA (10<= x <=1000) = 1005 if set to off
40087	2	Powerlimit Current Setting	For 30A Rating = x if set to x/100 A (0<= x <=3000) = 10050 if set to off
40088	2	TraceCheck Setting	= x if set to x hours (0<=x<=24) = 25 if set to off
40089	2	Heater Voltage Select	= x if set to x volts (0<=x<=600) = measured if set to 601
40090	2	Low Voltage Alarm Setting	= x if set to x Volts (85<= x <=300) = 301 if set to off

1. For manufacturer use only
2. Read only
3. Hardcode setting.
4. Not applicable to MS-2101

Modbus Register	Length Bytes	Variable Name	Value Range
40091	2	Proportional Control	= 0 if disabled = 1 if enabled
40092	2	Failure RTD Action	= 0 if heater turns on = 1 if heater turns off
40093	2	Manual Heater	b4-b0 = 0 if heater test is disabled = 1 to 24 if heater test is on for set hours = 25 if heater is on continuously b5 an b6 are not used
40094	18	Heater Name	First 16 bytes are heater name text string. Last 2 bytes are null terminator.
40103	2	Override	= 0 if it is off = 1 if it is on
40104	2	Deadband Setting	= x if set to x/10 °C (0<= x <=5000)
40105	2	Softstart	= x if set to x seconds (10<= x <=999s) = 1000 if set to off
40106	2	High Voltage Alarm Setting	= x if set to x Volts (100<= x <=300) = 301 if set to off
40107	2	Reserved for manufacturer use	
40108-40109	4	Reserved for future expansion	

Heater Status Group:

(Read only)

Modbus Register	Bytes	Variable Name	Value Range
40110	4	Heater Status	<p>First Byte: b0 : heater alarm present bit b1 : heater enabled bit b2 : heater setpoint on (not off or none) bit b3 : heater on bit b4 : heater test on/off bit b5 : tracecheck on/off bit b6 : module alarm present bit b7 : not used</p> <p>Second Byte: b1-b0 : output switch type 1 00 : solid-state₃ 01 : relay b2 : number of phases 1 0 : one phase 3 1 : three phase b4-b3 : RTD mode₁ 00 : no RTD 01 : one RTD 02 : two RTDs 3 03 : one thermocouple b5 : max current 1 0 : 30A 3 1 : 100A b6 : max GF current rate₁ 0 : 3A 1 : 1A 3 b7 : not used</p> <p>Third Byte: b3-b0 : number of heaters₁ 0001 : MS1or MS1 MKII 3 0010 : MS2 0101 : MS5 1010 : MS10 b5-b4 : output switch type 1 00 : solid-state 3 01 : relay 10 : user defined b6 : temperature measurement range₁ 0 : -50°C to +350°C 1 : -50°C to +500°C 3 b7 : not used</p> <p>Forth Byte: not used</p>

1. For manufacturer use only
2. Read only
3. Hardcode setting.
4. Not applicable to MS-2101

Modbus Register	Bytes	Variable Name	Value Range
40112	6	Heater Alarm Status	<p>First Byte: b0 : low temp alarm b1 : high temp alarm b2 : low current alarm b3 : high current alarm b4 : n/a b5 : n/a b6 : n/a b7 : n/a</p> <p>Second Byte: b0 : ground fault trip alarm b1 : ground fault alarm b2 : RTD A failure alarm b3 : RTD B failure alarm b4 : RTD A short alarm b5 : RTD A open alarm b6 : RTD B short alarm b7 : RTD B open alarm</p> <p>Third Byte: b0 : output SCR failure alarm b1 : TraceCheck ground fault alarm b2 : TraceCheck low current alarm b3 : TraceCheck high current alarm b4 : TraceCheck ground fault trip alarm b5 : TraceCheck output SCR failure alarm b6 : n/a b7 : low voltage alarm</p> <p>Forth Byte: b0 : high voltage alarm b1 : n/a b2 : n/a b3 : n/a b4 : GF test alarm b5 : self check fail b6 : continuity check fail b7 : TraceCheck continuity</p> <p>Fifth Byte: not used</p> <p>Sixth Byte: not used</p>

Heater Measured Values Group:
 (Read only)

Modbus Register	Bytes	Variable Name	Units
40115	2	Heater Control Temperature	(in units of tenth of degree Celcius)
40116	2	RTD A Temperature	(in units of tenth of degree Celcius)
40117	2	RTD B Temperature	(in units of tenth of degree Celcius)
40118	2	Heater On Percentage	(in unit percent)
40119	2	Heater Current	(in unit of 10mA)
40120	2	Reserved for manufacturer use	
40121	2	Reserved for manufacturer use	
40122	2	Ground Fault Current	(in unit of 1mA)
40123	2	Heater Voltage	(in unit of Volts)
40124	2	Pre-trip Ground Fault Current	(in unit of 1mA)
40125	2	Reserved for manufacturer use	
40126	2	Reserved for manufacturer use	
40127	2	Reserved for manufacturer use	
40128-40131		Reserved for future expansion	

Heater Statistics Group:

(Read only)

Modbus Register	Bytes	Variable Name	Units
40132	2	Maximum Temperature	(in units of tenth of degree Celcius)
40133	2	Minimum Temperature	(in units of tenth of degree Celcius)
40134	2	Maximum Heater Current	(in unit of 10mA)
40135	2	Reserved for manufacturer use	
40136	2	Reserved for manufacturer use	
40137	2	Maximum Ground Fault Current	(in unit of 1mA)
40138	4	Energy Used Last Day (32-bit floating point data)	(in unit of KWh)
40140	4	Energy Used Last Day (32-bit unsigned integer)	(in unit of KWh)
40142	4	Energy Cost Last Day (32-bit floating point data)	(in unit of Cents)
40144	4	Energy Cost Last Day (32-bit unsigned integer)	(in unit of Cents)
40146	4	Energy Used (32-bit floating point data)	(in unit of KWh)
40148	4	Energy Used (32-bit unsigned integer)	(in unit of KWh)
40150	4	Energy Cost (32-bit floating point data)	(in unit of Cents)
40152	4	Energy Cost (32-bit unsigned integer)	(in unit of Cents)
40154	4	Heater Turn On Hours (32-bit floating point data)	(in unit of Hours)
40156	4	Heater Turn On Hours (32-bit unsigned integer)	(in unit of Hours)
40158	2	Heater Percentage of Turn On Time	(in unit of Percent)
40159	2	Heater Turn On Days (32-bit floating point data)	(in unit of Days)
40161	2	Heater Turn On Days (32-bit unsigned integer)	(in unit of Days)
40163	2	Maximum Voltage	(in unit of Volts)
40164	2	Minimum Voltage	(in unit of Volts)

Heater Alarm Reset and Statistics Group:

Modbus Register	Bytes	Variable Name	Value Range
165	2	Reset TraceCheck Continuity Alarm	=0 Normal State =1 Reset
166	2	Reset Ground Fault Trip Alarm	=0 Normal State =1 Reset
167	2	Reset TraceCheck Ground Fault Alarm	=0 Normal State =1 Reset
168	2	Reset TraceCheck Low Current Alarm	=0 Normal State =1 Reset
169	2	Reset TraceCheck High Current Alarm	=0 Normal State =1 Reset
170	2	Reset TraceCheck Ground Fault Trip Alarm	=0 Normal State =1 Reset
171	2	Reset TraceCheck Switch Shorted Alarm	=0 Normal State =1 Reset
172	2	Reset Statistics	=0 Normal State =1 Reset
173	2	Reset Maximum Temperature	=0 Normal State =1 Reset
174	2	Reset Minimum Temperature	=0 Normal State =1 Reset
175	2	Reset Maximum Current	=0 Normal State =1 Reset
176	2	Reserved for manufacturer use	=0 Normal State =1 Reset
177	2	Reserved for manufacturer use	

Modbus Register	Bytes	Variable Name	Value Range
178	2	Reset Maximum Ground Fault Current	=0 Normal State =1 Reset
179	2	Reset Energy Used	=0 Normal State =1 Reset
180	2	Reset Energy Cost	=0 Normal State =1 Reset
181	2	Reset Turn On Hours	=0 Normal State =1 Reset
182	2	Reserved for manufacturer use	
183	2	Reserved for manufacturer use	
184	2	Reserved for manufacturer use	
185	2	Reset GF Test Alarm	=0 Normal State =1 Reset
186	2	Reset Maximum Voltage	=0 Normal State =1 Reset
187	2	Reset Minimum Voltage	=0 Normal State =1 Reset

Module Commissioning & Addressing Group:

Modbus Register	Bytes	Variable Name	Value Range
40188	2	Module Commission ₁	
40189	2	Test Module Address ₁	
40190	2	Assign Module Address ₁	

1. For manufacturer use only

Overview

You can use the procedures in this chapter to verify the proper operation of the MS-2101. Although not a complete functional verification, these tests will check major operating functions. The scope of testing includes field testing of the controller inputs/outputs with and without heat tracing cable. Before commissioning the controller, read *Chapter 2 Installation*. It provides important information about wiring, mounting and safety concerns. One should also become familiar with the controller as described in *Chapter 3 Getting Started* and *Chapter 6 Setpoint values*.

Requirements

The test procedures outlined in this chapter verify functions related to field application. These functions include RTD inputs, heater output, ground fault, current and voltage monitoring. To facilitate field testing, it is recommended functions be turned *off* or *disabled*. It is not mandatory that field testing be done. However, we recommend procedures in section *Placing the Controller in Service* be performed for all installations to verify proper operation and function of the equipment.

Safety Precaution



Dangerously high voltages are present on the power input and output terminals capable of causing death or serious injury.



Use extreme caution and follow all safety rules when handling, testing or adjusting the equipment.



The controller uses components that are sensitive to electro-static discharges. When handling the unit, care should be taken to avoid contact with terminal blocks.

Installation Checks:

1. Check that the line voltage to the power inputs does not exceed the name plate ratings.
2. Check that the current draw of the heat trace cable does not exceed the name plate ratings.
3. Check that the grounding stud is properly connected to ground.

RTD Input Test

Equipment:

Two Resistance Decade Boxes or RTD Simulator

Figure 9.1 Resistance versus Temperature in °C (DIN 43760 RTD)

°C	R (ohms)	°C	R (ohms)	°C	R (ohms)
-40	84.27	80	130.89	200	175.84
-30	88.22	90	134.70	210	179.51
-20	92.16	100	138.50	220	183.17
-10	96.09	110	142.29	230	186.82
0	100.00	120	146.06	240	190.46
10	103.90	130	149.82	250	194.08
20	107.79	140	153.58	260	197.69
30	111.67	150	157.32	270	201.30
40	115.64	160	161.04	280	204.88
50	119.39	170	164.76	290	208.46
60	123.24	180	168.47	300	212.03
70	127.07	190	172.16		

Figure 9.2 Resistance versus Temperature in °F (DIN 43760 RTD)

°F	R (ohms)	°F	R (ohms)	°F	R (ohms)
-40	84.27	160	127.50	360	169.29
-30	86.47	170	129.62	370	171.34
-20	88.66	180	131.74	380	173.39
-10	90.85	190	133.86	390	175.43
0	93.03	200	135.97	400	177.48
10	95.22	210	138.08	410	179.51
20	97.39	220	140.18	420	181.55
30	99.57	230	142.29	430	183.58
40	101.74	240	144.38	440	185.61
50	103.90	250	146.48	450	187.63
60	106.06	260	148.57	460	189.65
70	108.22	270	150.66	470	191.67
80	110.38	280	152.74	480	193.68
90	112.53	290	154.82	490	195.69
100	114.68	300	156.90	500	197.69
110	116.83	310	158.97		
120	118.97	320	161.04		
130	121.10	330	163.11		
140	123.24	340	165.17		
150	125.37	350	167.23		

To test RTD Input,

1. Disconnect the RTD(s) from the control module ensuring that the leads are adequately labelled.
2. Connect the resistance box as shown in figure 9.3.
3. Choose a test temperature for each RTD input and select corresponding resistances for each of the resistance decade boxes using the table of RTD resistances in figure 9.1 and 9.2. The temperatures for each RTD should be different. For the RTD simulator, set the test temperature of each unit.
4. Turn on power to the controller.
5. Using the RTD definition function (SETPOINT\HEATER SETUP\RTD DEFINITION), set to **Two RTDS Average**.
6. Display the temperature of each RTD (MEASURED\OPERATING VALUES\RTD-A ACTUAL) and (MEASURED\OPERATING VALUES\RTD-B ACTUAL). The two values should agree with the selected temperatures within the accuracy of the controller and test equipment.
7. If there is a significant discrepancy, consult the factory for service.

Heater Voltage and Current Test

Equipment:

- one voltmeter
- one clamp-on ammeter
- adjustable load bank (240VAC/10kW)
- 240VAC/30A single phase variac

Figure 9.3 Test Setup

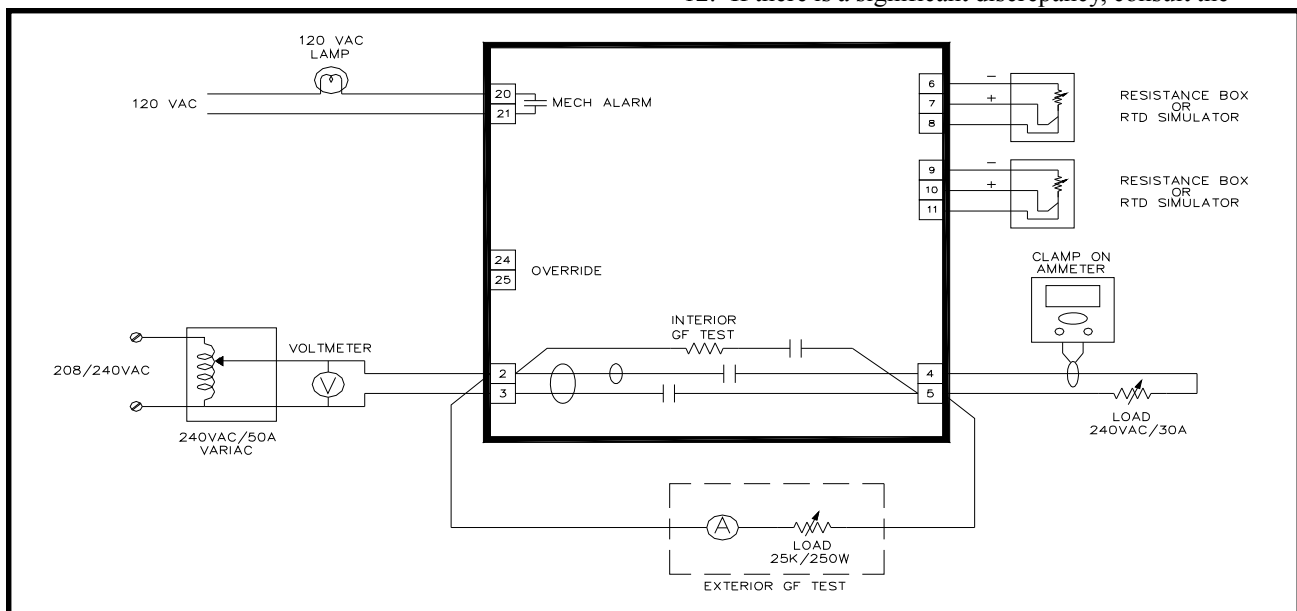

You can perform voltage and current measurement tests on the same test setup. Rather than using an adjustable load, you can use a fixed load in conjunction with a variac to adjust the input supply voltage.

To test heater voltage and current,

1. Disconnect any field wiring to terminals 2,3,4 and 5.
2. Connect the adjustable variac outputs to terminals 2 and 3. Connect the input supply of the variac to either 208 or 240VAC. 120VAC will work but will not provide an effective test range for voltage testing.
3. Connect the load bank to terminals 4 and 5.
4. Connect the voltmeter across terminals 2 and 3.
5. Connect a clamp-on ammeter around one of the load cables.
6. Set the variac control for 120VAC and turn on the power.
7. Force the heater *on* by setting the manual heater function for **1 hour** (SETPOINT\SETPOINT TEST\MANUAL HEATER).
8. Display the heater current (MEASURED\OPERATING VALUES\HEATER CURRENT).
9. Adjust the variac control within the voltage range of the controller and compare the readings of the display with the ammeter.
10. Display the heater voltage (MEASURED\OPERATING VALUES\HEATER VOLTAGE).
11. Adjust the variac control to take another set of readings. Repeat until enough readings are taken to cover the range. Current and voltage readings should be within the accuracy of the controller and test equipment.
12. If there is a significant discrepancy, consult the

factory for service.

Ground Fault Current Test

Internal GF Test

The controller comes with a ground fault test function that can be executed from the display (SETPOINTS\SETPOINT TEST\GF TEST).

To run this test,

1. Select start now
2. Go to ground fault current (MEASURED\OPERATING VALUES\GROUND FAULT CURRENT).

A ground fault current appears for the duration of the test. If the controller does not see a ground fault current, it will initiate a GF CT failure alarm indicating the ground fault monitoring function is not working. The GF test function only verifies for operation and does not check for measurement accuracy. To check for accuracy, the next test procedure applies.

External GF Test

Using the same test setup for voltage and current measurement tests, add the following components to the test setup.

Equipment:

One 240R/250W power resistor (load bank used in previous procedure may be disconnected and used in place)

One AC ammeter (0-1A range)

To test ground fault current,

1. Disconnect the load bank used in the previous test and reconfigure to 240R if possible.
2. Connect the load bank or power resistor to terminals 2 and 5 of the controller with the ammeter in series.
3. Set the variac control for 120VAC and turn on the power.
4. Force the heater on by setting the manual heater function for 1 hour (SETPOINT\SETPOINT TEST\MANUAL HEATER).
5. Change the GF trip alarm to **OFF** to prevent nuisance trips during the test. Reset ground fault trip alarms if necessary.
6. Display ground fault current (MEASURED\OPERATING VALUES\GROUND FAULT CURRENT).
7. Adjust the variac control to simulate various levels of ground fault currents through the load and compare readings from the display with the ammeter. Readings

should be within the accuracy of the controller and test equipment.

8. If there is a significant discrepancy, consult the factory for service.
9. Disconnect the load bank after the test.

Alarm Output Test

Mechanical Alarm

Equipment:

one 120VAC/100W Incandescent lamp with socket base

To test mechanical alarm contact,

1. Connect one lead of the lamp to terminal 20 of the controller.
2. Connect 120VAC to open lead of the lamp and terminal 21.
3. Power on the controller.
4. Ensure all alarms are turned off so that the controller is in no alarm condition.
5. Set SETPOINTS\SYSTEM SETUP\ALARM CONTACTS to MECH:NO SS:N/A. Lamp should be *off*.
6. Force alarm on by setting SETPOINT\SETPOINT TEST\ALARM TEST to **on for 1 hour**.
7. Lamp should be *on*.

Override Input Test

Equipment:

one 120VAC Incandescent lamp

To test override input,

1. Connect the 120VAC incandescent lamp to terminals 4 and 5.
2. Power on the controller.
3. Make a sure an RTD or simulator is connected to RTD1A input and set the equipment so that the control temperature is 100°C.
4. Set RTD definition function (SETPOINT\HEATER SETUP\RTD DEFINITION) to **1 RTD**.
5. Check the heater control temperature located at ACTUAL\OPERATING VALUES\CONTROL TEMP for 100°C.
6. Set the heater setpoint so that it is greater than the control temperature + deadband at SETPOINTS\OPERATING VALUES\HEATER SETPOINT. The deadband setting is located at SETPOINT\HEATER SETUP\DEADBAND.
7. The heater should be *on*. Verify by checking the lamp is *on*.
8. Set SETPOINTS\HEATER SETUP\OVERRIDE to **on**.
9. The heater should now be *off*. Verify by checking the lamp is *off*.
10. Short override input, terminals 24 and 25 with a short piece of wire.
11. The heater should be *on*. Verify by checking the lamp is *on*.

Placing the Controller in Service

Programming Setpoints

Before testing the controller with heat trace cable, program setpoints. Ensure the program enable dip switch or program access function in the display is set to enabled. It is recommended that you program setpoints in the operating values group. For users who are not familiar with the control functions, advanced functions such as those in the heater setup group should be disabled during initial startup to simplify troubleshooting.

Initial Startup

After programming setpoints in the operating values group, the controller is ready for test. Check field connections to make sure they are correctly wired. Power on the

controller and check the control temperature on the display (MEASURED\OPERATING VALUES\CONTROL TEMP). Verify that the temperature reading is valid. Assuming the pipe temperature is below the setpoint, the controller should be calling for heat.

Check heater voltage (MEASURED\OPERATING VALUES\HEATER VOLTAGE) on the display to verify with the line voltage.

Check heater current (MEASURED\OPERATING VALUES\HEATER CURRENT) on the display. If the controller is calling for heat, this value should be greater than zero; otherwise, a low current alarm or continuity alarm appears. This is an indication the heater is not properly wired or functioning correctly. The display value should correspond to the expected current draw of the heat trace.

Startup Problems

Breaker Trip Due to Inrush:

If self-regulating heat trace is used, it is possible the display will show O.L. (overload) because of the in-rush current exhibit in the heat trace during cold startup. The heater current range of the controller is up to 60A so that you can monitor inrush current. The heater current drops as the pipe temperature warms up. If the circuit breaker trips during startup, the inrush current is too high for the breaker rating. Check the heat trace design to make sure the breaker rating is appropriately sized. Inrush current can be reduced by enabling the softstart function.

To reduce inrush current,

1. Power down the controller.
2. Disconnect the heat trace cable from the controller.
3. Power up the controller without the heat trace
4. Set the softstart function to **999 seconds** if not turned on. (SETPOINTS\HEATER SETUP\SOFTSTART).
5. Power down the controller
6. Reconnect the heat trace to the controller.
7. Power up the controller again
8. Check the heater current on the display. The heater current should be dramatically reduced and gradually increase as the softstart function allows more current to flow.

Ground Faults:

Check ground fault current (MEASURED\OPERATING VALUES\GROUND FAULT CURRENT) on the display. Ground fault current should not be over 15mA; otherwise, ground fault trip or alarm appears on the display. To troubleshoot ground faults, check heat trace wiring and moisture in electrical junction boxes and connections.

Low and High Current Alarms with Self-Regulating Cable:

Setting values for low and high current alarms with self-regulating cable is more complicated since the heater output varies with temperature. High current alarms may occur during startup due to inrush currents and low current alarms may result when steady-state current is reached (pipe temperature is near setpoint). You can use the heat trace curve function that defines the heat trace power output against the pipe temperature to compensate the alarm settings and will be discussed later in this chapter. Otherwise, the high current alarm should be turned off and low current alarm set below the current rating of the cable at setpoint temperature.

Low Temperature Alarm:

During startup, a low temperature alarm is expected as cold fluid in the pipe slowly warms up. As the pipe temperature increases and exceeds the low temperature alarm setting, the alarm turns off. Eventually, the pipe temperature reaches setpoint, at which point the heater turns off. If the low temperature alarm and heater is on consistently, it is possible the heat tracing is not supplying enough heat. Either a higher wattage heat trace or longer length is required.

High Temperature Alarm:

A high temperature alarm occurs when pipe temperature exceeds the high temperature alarm setting. This can be caused by high feed temperature of the fluid. Placement of the RTD sensor near a hot area or direct exposure to sunlight may also cause a high temperature alarm. In this situation, improper pipe heating results. It is recommended that dual RTDs be used in pipes where there is large fluctuations in temperature.

Powerlimiting

You can use, powerlimiting when the total wattage of the heat trace cable is not required or to limit inrush current to the self-regulating cable. The powerlimit function is located at SETPOINT\HEATER SETUP\POWERLIMIT. A detail explanation of how this function operates is described in the *Chapter 1 Theory of Operation*. Powerlimiting is set by the desired operating current of the heat trace. For powerlimit to work properly, the powerlimit current should be below the nominal current rating of the heat trace. For example, if the heat trace draws 20A at its rated voltage and the application only requires 75% of its rated output, a powerlimit current of 15A will achieve a 75% reduction in power. With the powerlimit current set, the controller attempts to clamp the output current at that value.

The minimum powerlimit current setting should be greater than 10% of the nominal load current. This is because powerlimiting operates in 10% resolution. Choosing a powerlimit current below 10% causes the heater not to turn on since the average heater current at 10% (minimum duty cycle) exceeds the powerlimit current setting.

Be aware of how current alarms operate with duty cycle changes. Low current alarm is based on the nominal current ratings of the heat trace, not the average current. The low current alarm function converts actual current readings to the expected current value of the heat trace operating at 100% duty cycle prior to comparing against alarm settings. When using powerlimit, the high current alarm is disabled to prevent false alarms due to measurement error of the algorithm at low duty cycles. The error is always positive and therefore does not affect low current alarms.

Control Scheme

The MS-2101 controller supports two types of control scheme: on/off and proportional. The default is on/off switching which is used for majority of the applications. When on/off switching is used, the deadband setting determines the heater turn off temperature above the heater setpoint and the heater turn on temperature below the heater setpoint. The deadband setting is user definable located at SETPOINTS\HEATER\SETUP\DEADBAND. In applications requiring tighter control, you can use proportional control. To enable proportional control, locate message SETPOINTS\HEATER SETUP\PROPORTIONAL CONTROL. There is no proportional gain setting as this is automatically set by the controller to minimize errors. For further details how the proportional control function operates, refer to *Chapter 1 Theory of Operation*.

Heat Trace Curve

Self-regulating heat trace is very difficult to monitor because the heater current varies with temperature. The heat trace curve function provides a more effective means of monitoring this type of heat trace by knowing the power curve of the heat trace and compensating the alarm settings to prevent nuisance alarms. When using the heat trace curve function, low and high current alarms should be based on current draw of the heat trace at setpoint temperature. Locate and select the type of heat trace located SETPOINT\HEATER SETUP\HEAT TRACE CURVE SETUP.

If the heat trace being used is not one of the selections, obtain the curve parameters from the heat trace manufacturer's data sheets. The heat trace curve describes the power output per foot against pipe temperature and is defined by a straight line approximation. By drawing the best straight line through the manufacturer's curve, you can calculate the slope and y-intercept by identifying two points on the straight line. The controller requires units of Watt/ft-°F for slope and Watt/ft for offset (y-intercept). From message SETPOINT\HEATER SETUP\HEAT TRACE CURVE SETUP, select user and enter the slope and offset values for the curve.

RTD

The controller is defaulted to operate with one RTD. If both RTD inputs are used, you must define the control scheme. The RTD definition message is located at SETPOINT\HEATER SETUP\RTD DEFINITION. Select the control scheme that best suits the application. If uncertain, choose 2 RTDs averaged or 2 RTDs backup. Use 2 RTDs lowest in freeze protection or situations where it is important that the pipe temperature is maintained above setpoint. Use 2-RTDs highest in situations to prevent overheating. Use RTD B HT cutoff in special applications where a critical point is measured by RTD B and turns off the heater when RTD B temperature exceeds the high temperature alarm.

In the event of complete RTD failure, the controller can force the heater to default on or off. This is defined by message SETPOINT\HEATER SETUP\IF RTD FAILS HEATER GOES. The choice of **on** or **off** depends on the application.

Cost of Power

In order for the energy cost functions to provide correct information, you should enter the cost per KWh for electrical power at SETPOINT\SYSTEM SETUP\COST PER KWh.

Completing the Installation

At this point, the controller has been setup with enough information to control and monitor the heat trace. Other functions are less critical and a description on how these functions operate is located in *Chapter 6 Setpoint Values*. Read chapter 6 to gain an understanding of all the functions in order to customize the controller to the application requirements.

Ethernet Communication in BACnet/IP and MS-2101 Model Option “BAC/BAC1”

In *Figure 10.1*, BACnet/IP communication is added to MS-2101 heat tracing controller by MasterTrace Modbus to BACnet/IP gateway. The gateway (ex. BB3-7101 from Control Solutions, or FS-EZ1-MOD-BAC from Sierra Monitor) is interfacing a MS-2101 Modbus RTU control module to a BACnet/IP network. The gateway automatically polls the MS-2101 Modbus RTU control module at 9600 baud rate and stores the polling registers’ content to their respective configured BACnet objects. The Modbus RS485 side can connect to the serial port of MS-2101 control module over long distances (up to 4000 feet). Through Ethernet cable, the gateway presents a BACnet device object to the BACnet/IP network. This single BACnet device object could consist of up to 5000 data objects, enough to cover every Modbus register in MS-2101. A BACnet management system, such as building automation system, BACnet network discovery tool, or BACnet explorer, may then use standard BACnet services such as Read Property to access of the content of a read-only data object/Modbus register, or Write Property to change the content of a readable & writable data object/Modbus register.

BAC, an additional option, has been added to the MS-2101 heat tracing controller model options to allow customers to purchase Nextron MS-2101 heat tracing controller with BACnet/IP communication capability. **BAC1** is another option for gateway mounted in a FRP enclosure. Refer to *Chapter 1 Product Overview* for MS-2101 Models.

Figure 10.1 BACnet/IP Communication

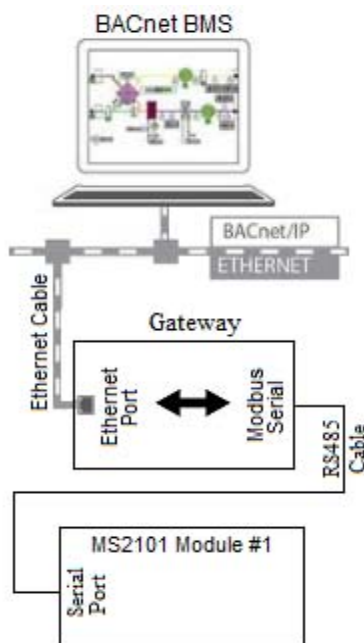

In a MS-2101 heat tracing control module with

BAC/BAC1 option, the MasterTrace Modbus to BACnet/IP gateway, as shown in *Figure 10.2*, is an assembled electronic unit, separated from MS-2101 module. It can be located as far as 4000 feet away from the module. To install it, use a 2 wire power cord to feed power to the unit and a RS485 cable to connect the unit and serial port of the MS-2101 module. An Ethernet cable is needed to connect the unit to Ethernet network. In this way, the gateway with default IP 172.19.24.180 joins the BACnet/IP communication network.

Figure 10.2 Configured Modbus to BACnet/IP gateway

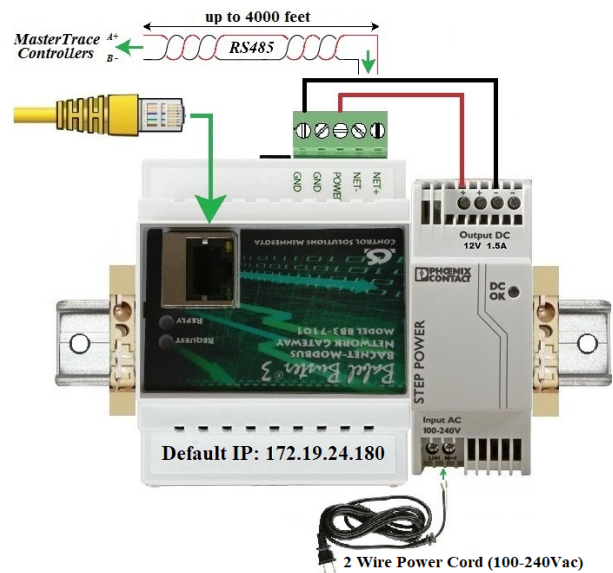

Configured MasterTrace Modbus to BACnet IP Gateway

The gateway in *Figure 10.2* is BB3-7101 or BB2-7010-01 or BB2-7010-01-10X from Control Solutions. There is a built-in web server “Babel Buster 3/2” with default IP 172.19.24.180 that can be accessed via web browser with user name and password. Through the web server, customer can configure various BACnet objects of interest. Three types of objects are commonly interested in MasterTrace heat tracing controller. They are analog input object, binary input object, and analog value object. (1) Analog input objects are created to poll their assigned modbus registers for heater measurement values such as RTD temperature, heater current, and ground fault current. (2) Binary input objects are created to reflect the binary signals of heater on/off status, heater alarm status, and specific alarm flags. They are constructed by extracting their specific bit within the heater status register 40110 (4 bytes) or heater alarm status register 40112 regularly polled from MS-2101 heat tracing module. (3) Analog value objects are created to monitor operation setpoints of interest, such as heater enable and heater setpoint. These writable objects can be updated via the HMI interface in the building management system.

Coming out of Nextron factory, the following BACnet

objects are configured in BB3-7101 or BB2-7010-01 or BB2-7010-01-10X Modbus to BACnet/IP gateway for Nextron-built MS-2101 heat tracing controller with model option *BAC/BAC1*.

Heater 1-1 Temperature (in unit of tenth of 1°C)
Heater 1-1 Current (in unit of 10mA)
Heater 1-1 GF Current (in unit 1mA)
Heater 1-1 On/Off status
Heater 1-1 Alarm Status
Heater 1-1 low temp alarm
Heater 1-1 high temp alarm
Heater 1-1 low current alarm
Heater 1-1 high current alarm
Heater 1-1 ground fault trip alarm
Heater 1-1 ground fault alarm
Heater 1-1 RTD A failure alarm
Heater 1-1 RTD B failure alarm
Heater 1-1 output SCR failure alarm
Heater 1-1 Tracecheck GF alarm
Heater 1-1 Tracecheck lo current alarm
Heater 1-1 Tracecheck hi current alarm
Heater 1-1 Tracecheck GF trip alarm
Heater 1-1 Tracecheck SCR fail alarm
Heater 1-1 low voltage alarm
Heater 1-1 high voltage alarm
Heater 1-1 high current trip alarm
Heater 1-1 high GF test alarm
Heater 1-1 continuity alarm
Heater 1-1 Tracecheck continuity alarm
Heater 1-1 Enable
Heater 1-1 Heater Setpoint

As mentioned above, field customers can use proper user name and password to access the built-in web server “Babel Buster 3/2” in the gateway with default IP 172.19.24.180 through any web browser to configure more BACnet objects of their interests on other additional MasterTrace heat tracing control modules, as long as (1) serial ports of all control modules are connected in daisy-chain fashion; (2) each control module is with a unique module number and at 9600 baud rate; (3) the total number of objects does not exceed the limit of 5000/1000.

Serial Communication in BACnet MS/TP network

In *Figure 10.3*, serial communication in BACnet MS/TP protocol is added to a group of 4 MasterTrace heat tracing control modules by Babel Buster BB2-3010, a BACnet MS/TP to Modbus Serial gateway from Control Solutions. The gateway has 2 sides. The Modbus Serial side can connect to the serial ports of MasterTrace control modules over long distances (up to 4000 feet) at 9600 baud rate. The USB Port side connects to MS/TP-Modbus gateway configuration tool from Control Solutions through a special USB MS/TP adapter (MTX002). This configuration tool is a software interface where customers can configure various BACnet objects. Three types of objects are commonly interested in MasterTrace heat tracing modules. They are analog input object, binary input object, and analog value object. (1) Analog input objects are created to poll their assigned modbus registers for heater measurement values such as RTD temperature,

heater current, and ground fault current. They are non-commandable objects. (2) Binary input objects are created to reflect the binary signals of heater on/off status, heater alarm status, and specific alarm flags. They are constructed by extracting their specific bit within the heater status register 40110 (4 bytes) or heater alarm status register 40112 regularly polled from MasterTrace heat tracing modules. (3) Analog value objects are created to monitor operation setpoints of interest, such as heater enable and heater setpoint. They are commandable objects. The BB2-3010 supports up to 300 non-commandable objects, or up to 135 commandable objects, or a mix in between.

Figure 10.3 BACnet MS/TP Communication

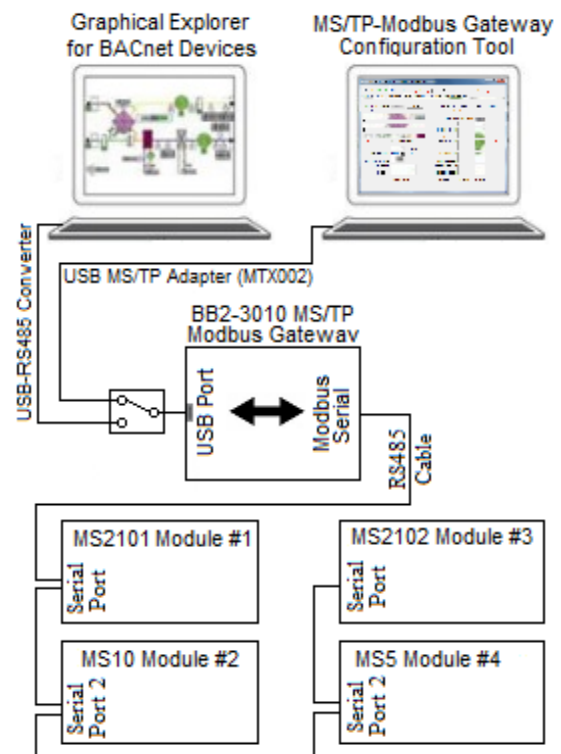

Upon successful configuration, the gateway will constantly update all the configured objects with data polled from their assigned modbus registers in the targeted MasterTrace control modules at the specified intervals. Through a USB-RS485 converter (or MTX002 in passthru mode) on its USB port, the gateway presents a number of live BACnet objects to the BACnet MS/TP network. A BACnet MS/TP supervisory controller or graphical explorer for BACnet devices may then use standard BACnet services such as Read Property to access of the content of a read-only data object/Modbus register, or Write Property to change the content of a readable & writable data object/Modbus register.

Ethernet Communication in Modbus TCP and MS-2101 Model Option “ETH/ETH1”

In *Figure 10.4*, Ethernet communication in Modbus TCP

is added to MasterTrace heat tracing control modules by Modbus TCP Ethernet to Modbus Serial gateway. The gateway (ex. GC-NET485-MB from Grid Connect) is a Modbus RS485 serial to Modbus TCP Ethernet converter. The RS485 side can connect to the serial port 2 of MasterTrace control modules over long distances (up to 4000 feet). The Ethernet side converts the serial Modbus

in a FRP enclosure. Refer to *Chapter 1 Product Overview* for MS-2101 Models.

Figure 10.5 Configured Ethernet to Modbus Serial Gateway

Figure 10.4 Modbus TCP Ethernet Communication

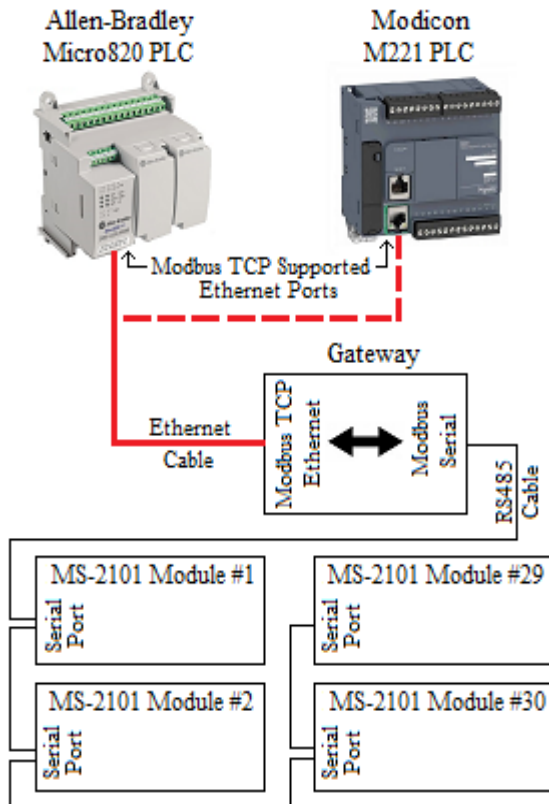

data stream to Modbus TCP Ethernet packets.

Connect a PLC or Automation system to the gateway through its Ethernet port and use it as the Master in the network. You can program the Master according to MasterTrace Modbus Communication Protocol to write/read data to/from MasterTrace control modules over Ethernet from anywhere in the plant as long as the Ethernet port on the PLC or Automation system is Modbus TCP supported and is assigned to an IP address that is different to the IP addresses of the gateway and other devices in the Ethernet network. Most of PLCs and Automation systems such as Micro820 from Allen-Bradley and M221 from Modicon do have this kind of Ethernet port as built-in.

ETH, an additional option, has been added to the MS-2101 heat tracing controller model options to allow customers to purchase Nextron MS-2101 heat tracing controller with Ethernet Modbus TCP communication capability. **ETH1** is another option for gateway mounted

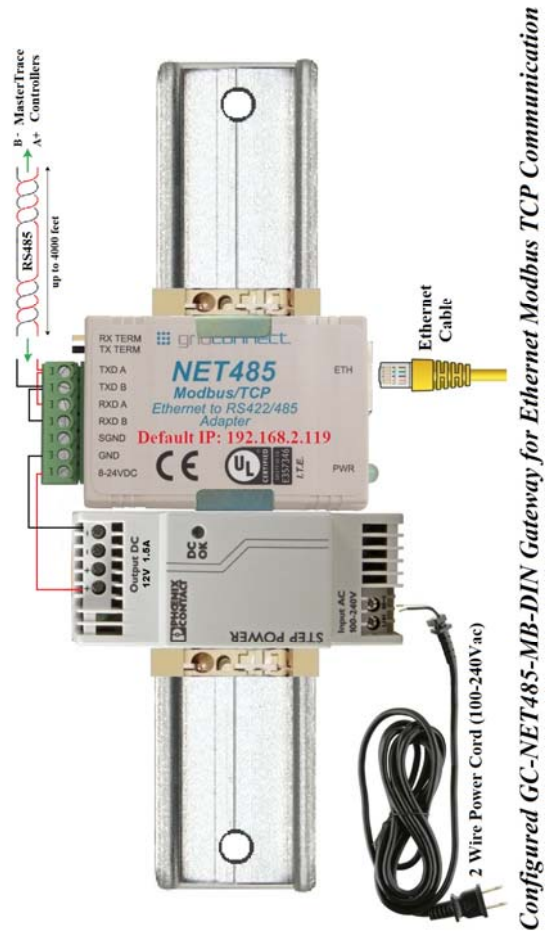

In a MS-2101 heat tracing control module with **ETH/ETH1** option, the Modbus TCP Ethernet to Modbus Serial gateway as shown in *Figure 10.5* is an assembled electronic unit, separated from MS-2101 module. It can be located as far as 4000 feet away from the module. To install it, use a 2 wire power cord to feed power to the unit and a RS485 cable to connect the unit and serial port of the MS-2101 module. Coming out of Nextron factory, the IP address of the gateway (GC-NET485-MB from Grid Connect) has been assigned to 192.168.2.119, and its serial port baud is set to 1200. An Ethernet cable is needed to connect the unit to Ethernet network. In this way, the gateway joins the Ethernet communication network of the PLC or Automation system.

An Important Note on Ethernet Gateways

In Figure 10.2 and 10.5, the same power supply from Phoenix Contact (Phoenix Contact 2868567, 8-24Vdc output, Din Rail, Class 1 Div 2) is used in both units of assembled Ethernet gateway. Its input power voltage

range is 100-240Vac. This makes it possible to locate the gateway unit beside the MS-2101 module and utilize the power from MS-2101 to feed the power supply from Phoenix Contact, as long as the MS-2101's input voltage is in a range of 100-240Vac. Use a pair of 14 AWG wires to connect MS-2101's terminal 2 & 3 to terminal L(+) & N(-) of the Phoenix Contact power supply, respectively. In this scenario, due to the limitation of maximum Ethernet cable length, the gateway can only be located less than 100 meters away from the Ethernet network hubs.

Warranty

The manufacturer warrants each control that it manufactures to be free from defective material or workmanship for a period of 12 months from date of purchase.

Under this warranty, the obligation of the manufacturer is limited to repairing or replacing the defective control at its option, when returned to the manufacturer's factory with shipping charges prepaid.

If failure has been caused by misuse, incorrect application or alteration of the control, this warranty will be void.

UNLESS SPECIFICALLY PROVIDED FOR IN WRITING IN THIS WARRANTY, EACH CONTROL IS PROVIDED WITHOUT ANY WARRANTY OF ANY KIND EITHER EXPRESSED OR IMPLIED. IN PARTICULAR, WITHOUT LIMITING THE GENERALITY OF THE FOREGOING, THE FOLLOWING IMPLIED WARRANTIES AND CONDITIONS ARE EXPRESSLY DISCLAIMED:

- a). **ANY IMPLIED WARRANTY OR CONDITION THAT THE CONTROL WILL MEET YOUR REQUIREMENTS.**
- b). **ANY IMPLIED WARRANTY OR CONDITION THAT THE OPERATION OF THE CONTROL WILL BE UNINTERRUPTED OR ERROR FREE; AND**
- c). **ANY IMPLIED WARRANTY OR CONDITION OF MERCHANTABILITY OR FITNESS FOR A PARTICULAR PURPOSE.**

The user shall be made aware that if the equipment is used in a manner not specified by the manufacturer, the protection provided by the equipment may be impaired.

**MASTERTRACE™
HEAT TRACING CONTROL**

Nexttron A Division of Powell 6120 11th Street S.E., Calgary, Alberta, T2H 2L7, Tel: (403) 735-9555, Fax: (403) 735-9559

P/N: 1501-0009 MS-2101 03/18 Printed in Canada